

UltraOil® (110-300)

Oil condensing boiler



United Kingdom

Hoval Ltd.
Northgate
Newark
Nottinghamshire NG24 1JN
Phone +44 1636 67 27 11
Fax +44 1636 67 35 32

Export

Hoval Aktiengesellschaft
Austrasse 70
LI-9490 Vaduz
Principality of Liechtenstein
Phone +423 399 24 00
Fax +423 399 24 11



- 1. Important notes 4**
 - 1.1 Important addresses and telephone numbers.....4
 - 1.2 System data5
 - 1.3 Calculation basis5
 - 1.4 Burner settings5

- 2. Safety 6**
 - 2.1 General safety instructions.....6
 - 2.2 Intended use7
 - 2.3 Explanation of the symbols7
 - 2.3.1 Warnings7
 - 2.3.2 Warning symbols.....7
 - 2.3.3 Information.....7

- 3. Functional principle of the heating system 8**
 - 3.1 Construction of the plant8

- 4. Control panel on heat generator 10**
 - 4.1 Overview of control panel10

- 5. Commissioning 11**
 - 5.1 Checks prior to operation11
 - 5.2 Switching on11
 - 5.3 Commissioning.....11

- 6. Heating system control..... 12**
 - 6.1 Function of the TopTronic® E control12
 - 6.2 Operating and display elements12
 - 6.3 What to do if...14
 - 6.4 Efficient control of the system.....15
 - 6.5 Individual day and week programs16
 - 6.6 Start screen17
 - 6.6.1 Elements of the start screen heat generator and living area18
 - 6.6.2 Optional start screen.....20
 - 6.7 Main settings22
 - 6.7.1 Changing the room temperature.....22
 - 6.7.2 Adapt hot water temperature23
 - 6.7.3 Select heating circuit (if there are several)24
 - 6.7.4 Change the basic program (heating circuit)24
 - 6.7.5 Change active day program (heating circuit)25
 - 6.7.6 Change basic and day program (hot water)26
 - 6.7.7 Call up system information28
 - 6.7.8 Joint operation for heating and domestic hot water circuits.....28
 - 6.8 Basic programs29
 - 6.8.1 Functions of the various basic programs29
 - 6.8.2 "Holiday" – enter return date30
 - 6.9 Week programs.....32
 - 6.9.1 Week program default settings32
 - 6.9.2 Notes on personal week programs33
 - 6.9.3 Week program operating elements.....34
 - 6.9.4 Adapt week program35
 - 6.9.5 Rename week program37
 - 6.9.6 Reset week program39
 - 6.10 Day programs / switching cycles.....41
 - 6.10.1 Default settings for day programs / switching cycles.....41
 - 6.10.2 Notes on personal day programs.....42
 - 6.10.3 Party and absent43
 - 6.10.4 Day program / switching cycles operating elements45

- 6.10.5 Change room temperatures and switching cycles in the day program 46
- 6.10.6 Rename day program 48
- 6.10.7 Reset day program 50
- 6.11 Hot water 52**
- 6.11.1 Hot water operating elements 52
- 6.11.2 Week programs – hot water 53
- 6.11.3 Week program default settings – hot water 53
- 6.11.4 Day programs / switching cycles for hot water 54
- 6.11.5 Default settings for day programs / switching cycles – hot water 54
- 6.11.6 Legionella function 55
- 6.11.7 Recharging hot water 56
- 6.11.8 Set hot water program to absent 57
- 6.12 Other operating elements 59**
- 6.12.1 Main menu view 1 59
- 6.12.2 Main menu view 2 60
- 6.12.3 Main menu view 3 61
- 6.12.4 Power station 62
- 6.12.5 Power station 63
- 6.12.6 Programs 64
- 6.12.7 Heating circuit 65
- 6.12.8 Info 66
- 6.12.9 Analysis 67
- 6.12.10 Emission - only for heating specialist 68
- 6.12.11 Manual operation 69
- 6.12.12 Presentation 1 70
- 6.12.13 Presentation 2 71
- 6.12.14 Presentation 3 72
- 6.13 Further settings 73**
- 6.13.1 Set/change WiFi password 73
- 6.13.2 Setting the language 73
- 6.13.3 Adapt start screen individually 73
- 6.13.4 Rename heating circuit 73

- 7. Alarm messages 74**
- 7.1 Display alarm message 74
- 7.2 Instructions in the event of faults 75
- 7.3 Resetting the faults 75
- 7.4 Control related alarm messages 76
- 7.5 Plant-related alarm messages 76

- 8. Maintenance and inspection (heating system) 78**
- 8.1 Checking the water pressure 78
- 8.2 Top up with water 78
- 8.3 Cleaning 79
- 8.4 Decommissioning 79

- 9. Saving energy 80**
- 9.1 Specific steps for saving energy 80

- 10. Waste disposal 81**
- 10.1 Disposal instructions 81

1. Important notes

Dear Customer,

With the Hoval UltraOil®, you have acquired a product manufactured according to the state-of-the-art and to the highest quality standards.

For the correct installation and operation of your Hoval UltraOil®, all applicable laws, regulations and standards must be complied with as well as the regulations of the responsible energy supply company. If you have any questions, please contact the installer of your heating system.

Assembly and installation of the boiler are only allowed to be carried out by trained personnel from a licensed specialist company. Before commissioning, an installation inspection and approval of the overall installation by the heating specialist are required.

To guarantee safe and trouble-free operation, operate your Hoval boiler in accordance with these operating instructions at all times.

The boiler is only allowed to be used for its intended purpose and with fuels for which it was designed and which have been approved by Hoval.

Do not carry out any modifications to the system, otherwise all claims under the warranty will be waived. Conversion kits must be installed and the installation approved by the heating specialist or by the Hoval Customer Service.

Reliable and safe functioning of a boiler, as well as the achievement of optimum efficiency and clean combustion are only possible and guaranteed if the system is serviced and cleaned at least once every year. Please pay particular attention to the instructions in this manual.

In the event of a fault or in the event of damage, please contact the Hoval Customer Service to inquire about the necessary repairs. In the meantime, shut down the unit to avoid any damage.

Provided it is used correctly, your Hoval boiler will ensure you enjoy a well heated home for many years.

Hoval Customer Service

If you have any doubts with regard to the operation of your Hoval boiler, or if minor faults affect its correct functioning, please contact Hoval Customer Service centre. Our trained Customer Service staff will be pleased to help you.

An optimally set heating system can not only save you a lot of trouble, but also a lot of money.

Take advantage of the Hoval Customer Service offerings for regular maintenance, to prolong the service life and warranty period of your Hoval heating system, and inquire about a service agreement with extended warranty. Your Customer Service consultant will be pleased to advise you!

You will find the addresses on the last page.

Please pay particular attention to the information in this manual!

1.1 Important addresses and telephone numbers

Heating specialist

.....
.....

Plumber:

.....
.....

Electrician:

.....
.....

Fuel supplier:

.....
.....

Chimney sweep:

.....
.....

Oil burner service:

.....
.....

Tank cleaning:

.....
.....

1.2 System data

To be filled in by the heating specialist!

Order No. / serial number:

Heat generator type:

Calorifier:

Electric immersion heater: kW V

Heating circuit pump:

Mixing valve:

Room control module Yes No

Integrated room sensor activated: Yes No

Neutralisation unit: Yes No

Condensate pump: Yes No

Outdoor temperature sensor: Yes No

Combustion air supply Independent of room air: Yes No

Number of heating circuits: 1 2
 3

Switching time programmes individually set: Yes No

Legionella function activated: Yes No

1.3 Calculation basis

Lowest design outside temperature (°C):

Heat energy demand (kW):

Max. flow temperature (°C):

1.4 Burner settings

To be filled in by the boiler expert!

Set firing heat output
 Burnner: min. kW
 max. kW
 Flue gases: °C

2. Safety

2.1 General safety instructions



The system may only be placed in operation if all the relevant standards and safety regulations have been complied with. Fault-free operation

can only be guaranteed if the operating instructions are followed.

The rectification of faults and damage resulting from installation in unsuitable rooms, e.g. hobby rooms, workshops, etc. as well as the use of contaminated operating materials (gas, water, combustion air), unsuitable chemical additives to the heating water, improper handling, faulty installation, unauthorised modifications and damage due to the use of force do not fall under our obligations under warranty.

Behaviour in case of danger

Cut off the fuel (oil) and electricity supplies.

Disconnecting the electrical power supply

The heat generator can only be de-energised by disconnection from the mains (fuse). Even when the blocking switch is set to "0", the plant is still live. Electric shocks can cause fatal injuries and lead to fires.

If you smell flue gas

Leaking flue gas represents a risk of poisoning.

- Turn the system off
- Open windows and doors
- Notify the specialist company

Supply air openings

Air inlets and outlets must not be closed. Danger of poisoning due to incomplete combustion if the supply air openings are closed.

Exception: Your system is room-sealed - see chapter 1.2 page 5.

Filling the oil tank

When the oil tank is filled, the plant must always be switched off with the blocking switch on the boiler. It is only allowed to be switched on again after waiting for about 2 hours. Filling the oil tank must be monitored by the oil supplier. We cannot accept any liability for tank overflows.

Initial commissioning / installation inspection

Initial commissioning of a newly installed system may only be carried out by a heating specialist. Danger of poisoning due to incorrect commissioning! A full installation inspection must be completed prior to start-up.

Checking the water pressure

Check the water pressure in the system at regular intervals, as described in chapter 8.1 page 78.

Burner settings

Your Hoval burner was adjusted at the plant to match the boiler capacity. The fine tuning is performed by the heating specialist or Hoval customer service during the trial operating run (chapter 1.4 page 5).

Filling the heating system

The replacement water must be of the required quality. The quality requirements are stated in the installation instructions in the "Water quality" chapter (Filling and replacement water).

Suitable fuels

Only operate the boiler with the fuel stated on the boiler rating plate. The UltraOil® boiler is suitable for the combustion of the following fuels:

- Low-sulphur heating oil EL in accordance with DIN 51 603 / ÖNorm C 1109
- Eco heating oil low-sulphur SN 181 160-2 / 2008

The low-sulphur EL heating oil must be free from metallic additives that create ash. Most standard low-sulphur EL heating oil types meet these requirements, although if in doubt ask about the properties and have the suitability confirmed. Admixing up to 10 % FAME (EN 14213) is possible.

Maintenance, cleaning and inspection

The boiler, burner and water heater must be serviced regularly by a heating specialist. An important precondition for economical operation and for maintaining good air quality is the sound technical condition of your burner system. The burner must be inspected by a heating specialist once a year.

Taking out of operation / frost protection

The system must be emptied if there is a risk of frost. The heating specialist will explain the system to you.

Corrosion protection

Do not use sprays, solvents, chlorine-based cleansing agents, paint, adhesives etc. in the proximity of the unit. Under certain circumstances, these substances can cause corrosion inside the boiler and the flue gas system!

Keep the room clean

Keep the room in which the boiler is installed clean at all times and turn off the burner before starting cleaning to avoid any faults due to dusty combustion air.

2.2 Intended use

The Hoval UltraOil® boiler is exclusively intended for heating the heating water. It is only permitted for fuels defined in chapter 2.1 page 6 to be used.

The heat produced must be carried away by the heating water. All boiler openings must be closed during operation.

Only use the boiler if in perfect technical condition, as well as according to the intended use, safely and with regard to potential dangers!

The inspection and cleaning intervals stated in the documents must be complied with. Malfunctions that could impair safety must be rectified immediately!

The manufacturer/supplier will not accept any liability for any other use, or use beyond the scope of these definitions, and any resulting damage.

2.3 Explanation of the symbols

2.3.1 Warnings



DANGER

... indicates a situation of immediate danger which will lead to serious or fatal injuries if not avoided.



WARNING

... indicates a situation of possible danger which can lead to serious or fatal injuries if not avoided.



CAUTION

... indicates a situation of possible danger which can lead to minor or slight injuries if not avoided.



NOTICE

... indicates a situation of possible danger which can lead to damage to property if not avoided.

2.3.2 Warning symbols

The following warning signs are combined for the warning notes with signal words CAUTION, WARNING and DANGER.



General warning symbols



Warning of electrical voltage

2.3.3 Information



Information:

Provides important information.

ENERGY



Energy-saving tip:

Provides information about saving energy.



Provides important information about the ecological use of your Hoval plant.



Recycling involves the reuse of waste products and/or their precursors as secondary raw materials.

3. Functional principle of the heating system

3.1 Construction of the plant

Depending on the type of heating system selected, some of the components might be different from the presentation below. The heating specialist will explain the system to you.

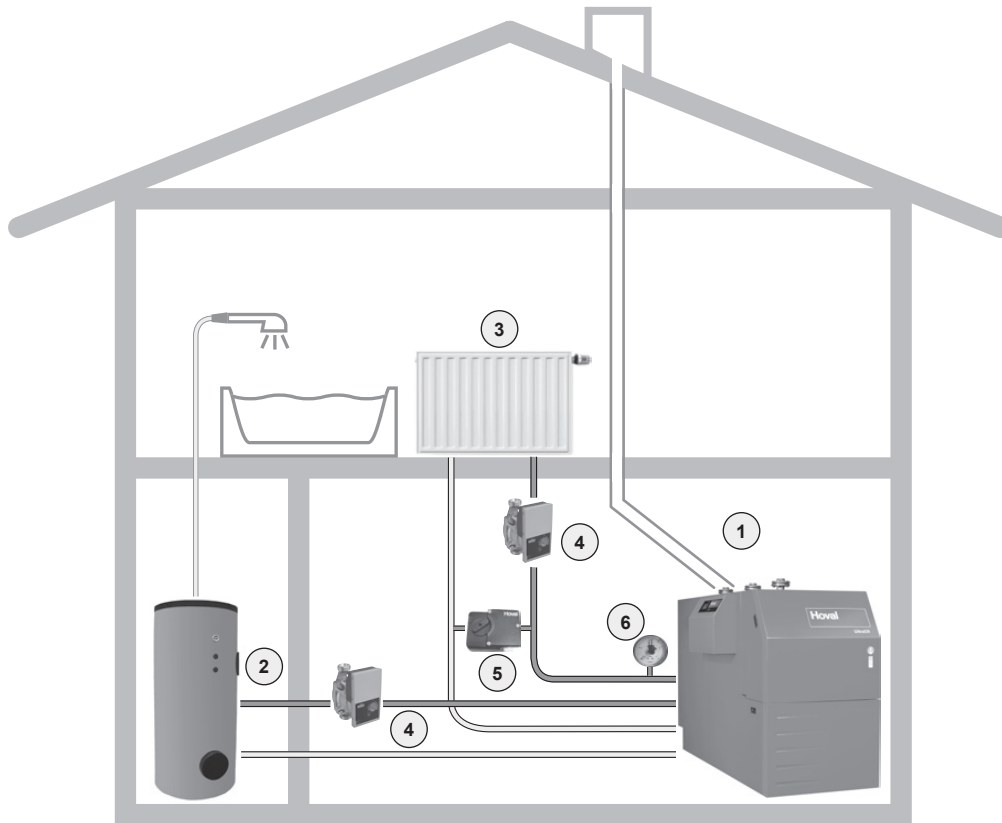

The heating water heated by the boiler is supplied to the radiators or is used to heat up the hot water (calorifier).













Figure	Components	Function / description
	Oil-fired boiler	Burns oil safely and in an environmentally friendly manner. Extracts the heat from the gases produced during combustion and transfers it to the heating water.
	Heating oil	The process of combustion within the boiler converts the energy contained in the oil into heat.
	Calorifier	Holds a reserve of hot process water for household consumption (e.g. for showering).

	Figure	Components	Function / description
		Control panel / Control module	Controls and monitors the operation of the boiler. Maintains the desired room temperature optimally and fuel-efficiently, independent of the outside temperature.
3		Radiator, underfloor heating	Releases the heat of the heating water into the room.
4		Heating pump	Transports the heating water from the boiler to the radiators and back into the boiler, where it is re-heated.
		Heating pipes	Transport the heat which is generated (heating water) from the boiler to the radiators.
5		Mixing valve	Adjusts the heating flow temperature by mixing in colder heating return water (water flowing from the radiator) to maintain the desired room temperature, independent of the outside temperature.
6		Pressure gauge	Displays the water pressure in the heating system.
		Air vent	Ensures that the heating pipes contain only heating water and no air.
		Safety valve	Prevents overpressure in the system.
		Diaphragm pressure expansion tank	Maintains the pressure in the system at a constant level and absorbs the expansion water.

4. Control panel on heat generator

4.1 Overview of control panel

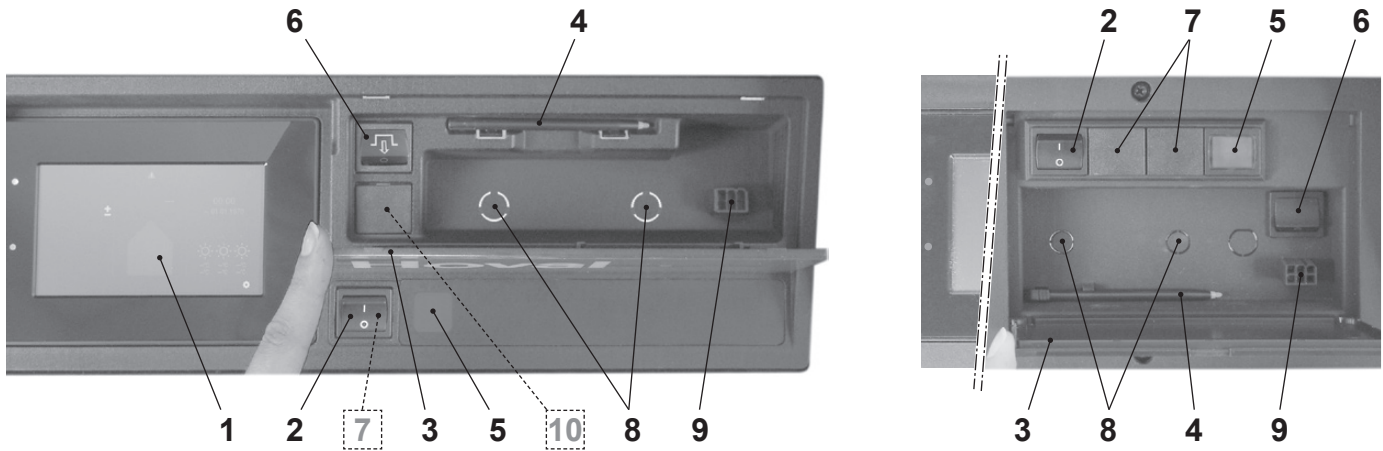

No.	Designation	Function
1	TopTronic® E control module	Used as operator terminal for the plant that can be operated by touching with the finger or stylus (no. 4). For a detailed description of the elements, see chapter 6.6.1 page 18.
2	Blocking switch	1 = ON Heat generator in operation 0 = OFF Heat generator not in operation (plant live; no frost protection)
3	Flap	To protect the folding compartment with stylus (no. 4), reset button (no. 6) and service plug (no. 9). Safety temperature limiter optional (no. 8)
4	Stylus	Stylus for operating the control module
5	Fault lamp	Lights up if there is a heat generator fault.
6	Reset button	Used for resetting if the failure indication lamp lights up. <div style="display: flex; align-items: center;"> <p>The reset button is allowed to be pressed once at most. If the failure indication lamp continues to be lit, please contact Hoval Customer Service.</p> </div>

Optional:

7	Bivalent switch (optional)		Used for switching priority in plants with several heat generators or for other plant-specific switching functions.ww
8	Additional safety temperature limiter (optional)		Optional installation of an additional safety temperature limiter. Used for interrupting the heat generator if a set temperature is exceeded.
9	Service plug		Used exclusively by the service technician.

Only available for specific heat pumps:

10	Mains isolator switch		Below the reset button, there is a mains isolator switch with which the heat pump can be completely disconnected from the electrical power supply.
----	------------------------------	---	--

5. Commissioning

5.1 Checks prior to operation

- Check the water pressure in the heating system
- Check the oil level in the oil tank with a dipstick
- Open shut-off valve in the heating flow and return
- Check fresh air supply to the heating system
- Check the settings for the operating modes
- Check the settings for the boiler control elements
- Check the oil supply to the burner (open the shut-off slide valve in the oil line)
- Check the electrical power supply (switch on fuse, turn the emergency switch to "On" or connect the plug)

5.2 Switching on

1. Turn on main switch (if fitted).
2. Set blocking switch to "I".
3. Set the basic program and temperature on the boiler (chapter 6.4 page 15).

5.3 Commissioning



WARNING

Danger of poisoning due to incorrect commissioning!

Initial commissioning of a newly installed system may only be carried out by a heating specialist. A full installation inspection must be completed prior to start-up.

6. Heating system control

6.1 Function of the TopTronic® E control

The TopTronic® E control module is used for controlling your heating system. Using the touch-sensitive screen (referred to below as touchscreen), you can make various settings on your system at the touch of a fingertip or using the stylus.

NOTICE



The surface of the TopTronic® E control module is not allowed to be touched with sharp or pointed objects for operation – risk of scratching.

The control module has the following functions:

- Maintaining the desired room temperature independent of the outside temperature
- Heating the living space only when required
- Producing hot water only when required
- Displaying information about the system

Further functions:

- Making it possible to set the desired temperatures and select a basic program (chapter 6.8 page 29)
- Turning the heat generator ON/OFF
- Monitoring temperatures

All the basic settings will have already been carried out by Hoval, or the heating engineer, during commissioning of the heating system. You can make further settings if you go on a journey or if your home is too cold or too warm. You can find an overview of the most frequently asked questions in chapter 6.3 page 14.



How to save energy!

For your benefit and for the environment

Using energy more efficiently by avoiding unnecessary losses! With little effort, you can optimise the operation of your heating system and save energy at the same time.

It is worth setting your personal day and week programs

You can save valuable energy and money by specifically adjusting the heating times with a personal day or week program to take account of the times when you will be present and absent. The TopTronic® E control makes it very simple to set different switching cycles for individual daily sequences (chapter 6.9 page 32).

6.2 Operating and display elements

The graphical displays on the control module can be operating or display elements.



If the TopTronic® E control module is in sleep mode, it can be “woken up” by touching the touchscreen. Sleep mode and the duration until the mode starts can be adjusted (chapter 6.12.13 page 71, nos. 3 and 4).

Operating elements



Operating elements are understood to be the buttons on the control module that can be selected by touching in order to adjust various settings. The operating elements are shown in white on a black background or in black on a white background. Values that can be changed with plus (+) or minus (–) can be touched directly. As a result, a keypad appears on the control module which helps you to make the entry.

Display elements

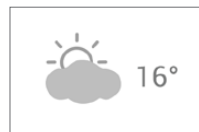

Display elements only provide information and cannot be selected. They are shown in colour.

Room temperature – coloured marking

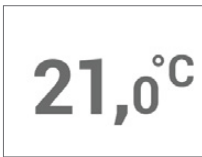

The room temperature on the start screen is shown in three different colours. The colours have the following meaning:

Colour	Meaning
Orange	Heating Heating operation active. The room is heated to the desired room temperature.
Blue	Cooling (optional: for heat pumps only) Cooling operation active. The room is cooled to the desired room temperature.
Grey	Inactive Heating/cooling operation inactive.

LED operating status

An LED indicator is additionally attached on the left of the control module. This displays the operating status and can light up in the following three colours:

Colour	Meaning
Green	Correct operation General information or warnings may be displayed on the control module. You as the customer do not need to do anything, however! Heating operation is continued.
Orange	Blocking The heat generator has been temporarily blocked because of an error. Contact Hoval customer service if the blocking leads to inadvertent cooling down of the heating system.
Red	Locking The heat generator sent a critical error and has been locked for safety reasons. The heat generator cannot continue to operate. Contact Hoval customer service!

LED indicator

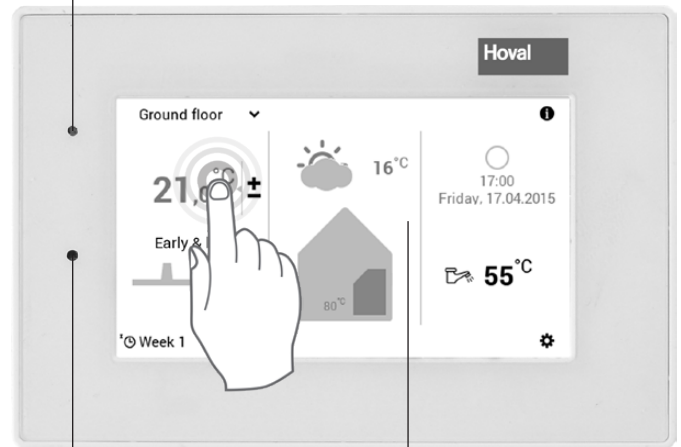

Brightness sensor

Touchscreen

6.3 What to do if...

The following information can be used as a first level support in frequently occurring situations.

Observation	Remedy	Chapter / page
It is too cold.	Select Room temperature on the start screen and press the plus (+) button to increase the room temperature.	6.7.1 page 22
It is too warm.	Select Room temperature on the start screen and press the minus (-) button to reduce the room temperature.	6.7.1 page 22
From now on, equal day and night temperatures should be maintained continuously.	Select Basic programs on the start screen and choose the Constant basic program. Set the desired room temperature.	6.7.4 page 24
This evening, the heating should remain on for longer.	Select Day programs on the start screen. Under "Select day program", set Party and enter the duration and room temperature.	6.10.3 page 43
A larger amount of hot water is required.	Select DHW temperature (tap icon) on the start screen and press the plus (+) button to increase the water temperature. If necessary, recharge domestic hot water ("Recharging").	6.7.2 page 23 / 6.11.7 page 56
	 You can also access the function for setting the water temperature using Main menu (⚙️) > Hot water .	
From now on, hot water but no heating is required.	Set Heating circ. to Standby basic program and Hot water to the required basic program . Heating operation OFF, hot water ON.	6.7.4 page 24
Suddenly, there is no heating or hot water; it is cold.	Check the control module for alarm messages and consult a heating engineer, if necessary. Check if there is still sufficient fuel/Electricity available, if necessary.	Alarm messages chapter
I will be absent for several hours during the day today.	Select Day programs (e.g. all day) on the start screen. Under "Select day program", set another day program or Absent (enter the duration and room temperature).	6.7.5 page 25 / 6.10.3 page 43
I am travelling for a certain period of time (e.g. two weeks).	Select Basic programs on the start screen and choose the Holiday basic program. Set return date minus at least 1 day.	6.8.2 page 30
I am going away for an indefinite period of time.	Select Basic programs on the start screen and choose the Standby basic program. Change the basic program when you return.	6.7.4 page 24
In summer, it is too cold or too warm.	The basic program enables you to tell which operating mode is active. Adapt the required basic program as you need to.	6.7.4 page 24

6.4 Efficient control of the system

You can save a lot of energy by efficient adjustment of the heating operation. The TopTronic® E control module provides basic programs (6.8 page 29) that help you to control your system easily and specifically when you are present and absent over a fairly long period of time.

For short-term changes to the heating times, you can use various day programs in the Week 1 and Week 2 basic programs (6.10 page 41). Furthermore, the living area temperature can be increased or reduced effortlessly by selecting the current room temperature.

Basic programs

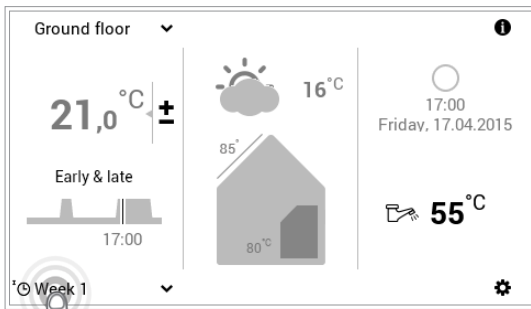

See "Week programs" chapter

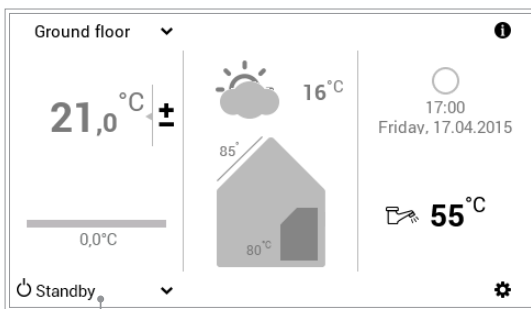
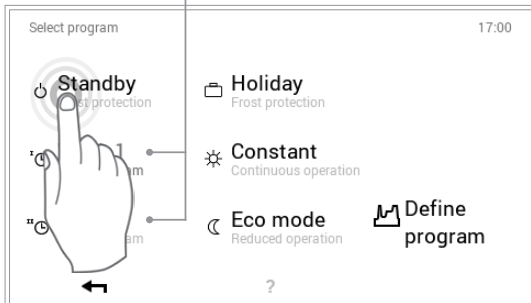

New active basic program

Room temperature / day programs

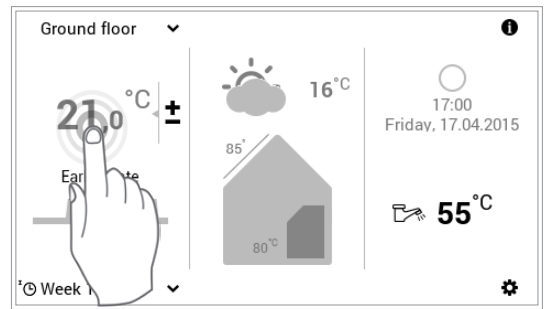

Heating circuit Active day program

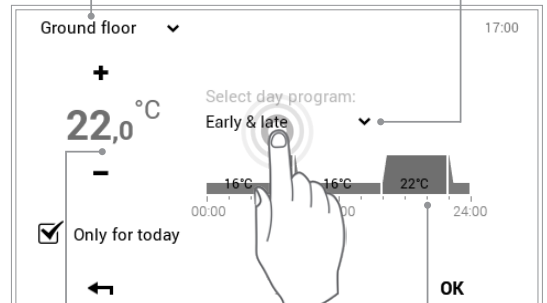

Desired room temperature Switching cycle

Active day program Day program selection



Day program "Party" Day program "Absent"

6.5 Individual day and week programs

To save you the trouble of selecting the required basic program every day, the control module of the TopTronic® E offers you the opportunity of using week programs. In the two basic programs that can be selected, you can plan your individual week sequences and assign day programs (6.10 page 41) to adapt the heating times to your presence and absence using switching cycles. In

the basic settings, the control module already contains the two standard week programs, Week 1 and Week 2 (6.8 page 29). You can edit the two week programs individually (6.9.4 page 35) and give them any name (6.9.5 page 37).

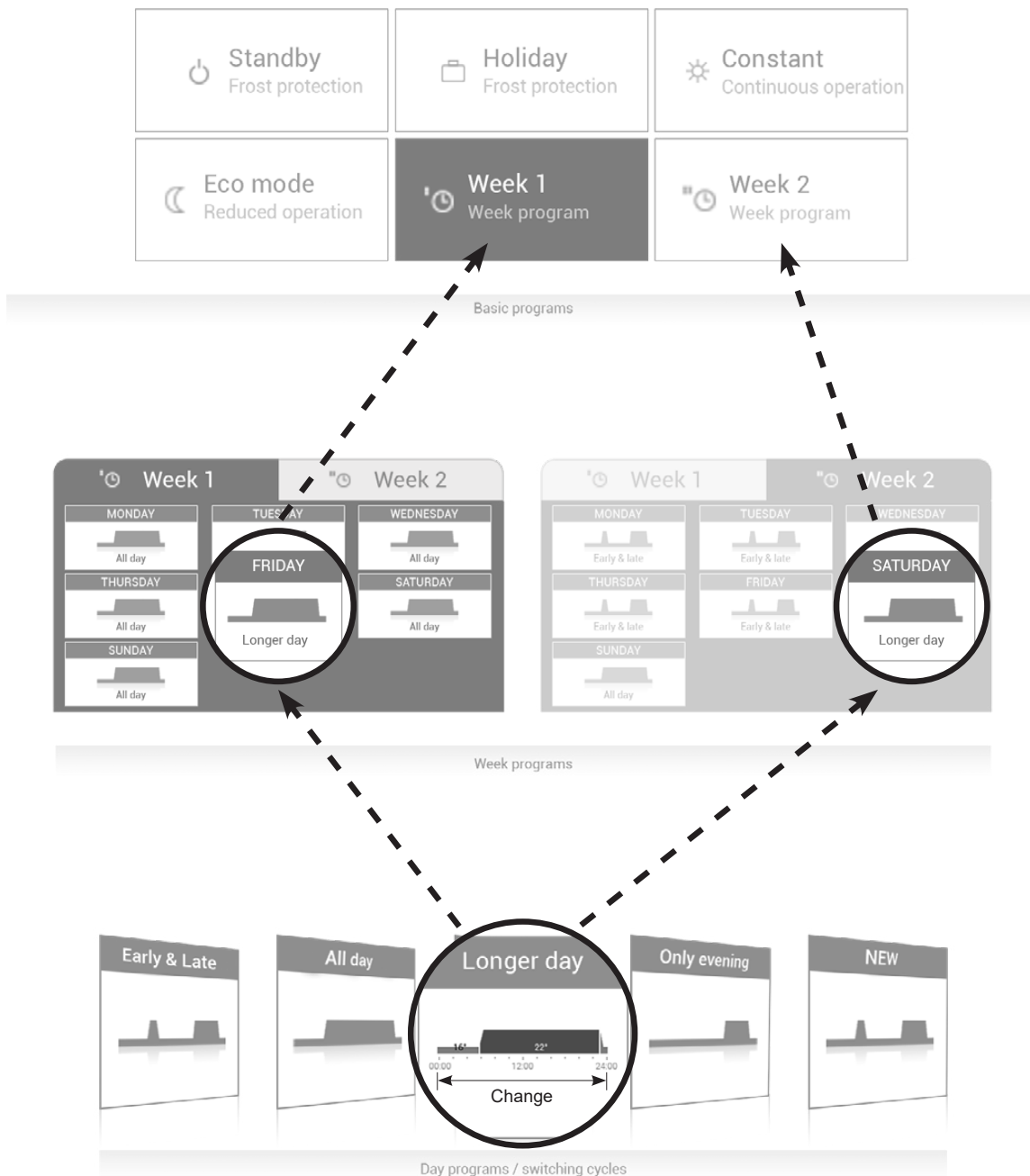

6.6 Start screen

The start screen of the control module is divided into three vertical display elements. For a detailed list of the various start screen functions, refer to 6.6.1 page 18.



NOTICE

The surface of the TopTronic® E control module is not allowed to be touched with sharp or pointed objects for operation – risk of scratching.

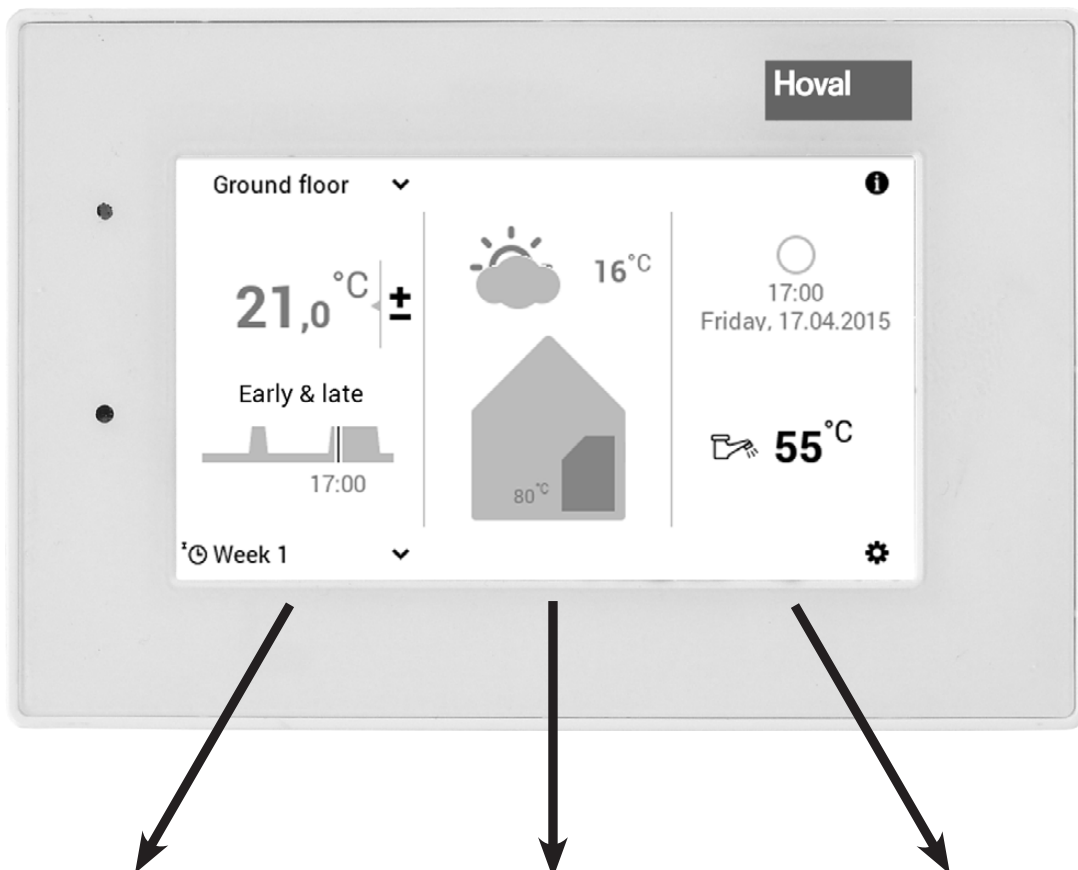

Information living area

The left third of the start screen contains information about the living area. Here, you can make settings for the heating circuit, current room temperature, day program and switching cycles as well as basic program (chapter 6.4 page 15).

Information heat generator

The middle third of the start screen contains information about the heat generator. This information area displays the error status, the outside temperature as well as information about the heating circuit. In addition, the user level (referred to below as authorisation level) can be displayed.

Information general

The right third of the start screen contains general information. Information about energy consumption, time/date as well as domestic hot water temperature. In connection with the TopTronic® E online, the weather forecast is displayed on the control module as an option.







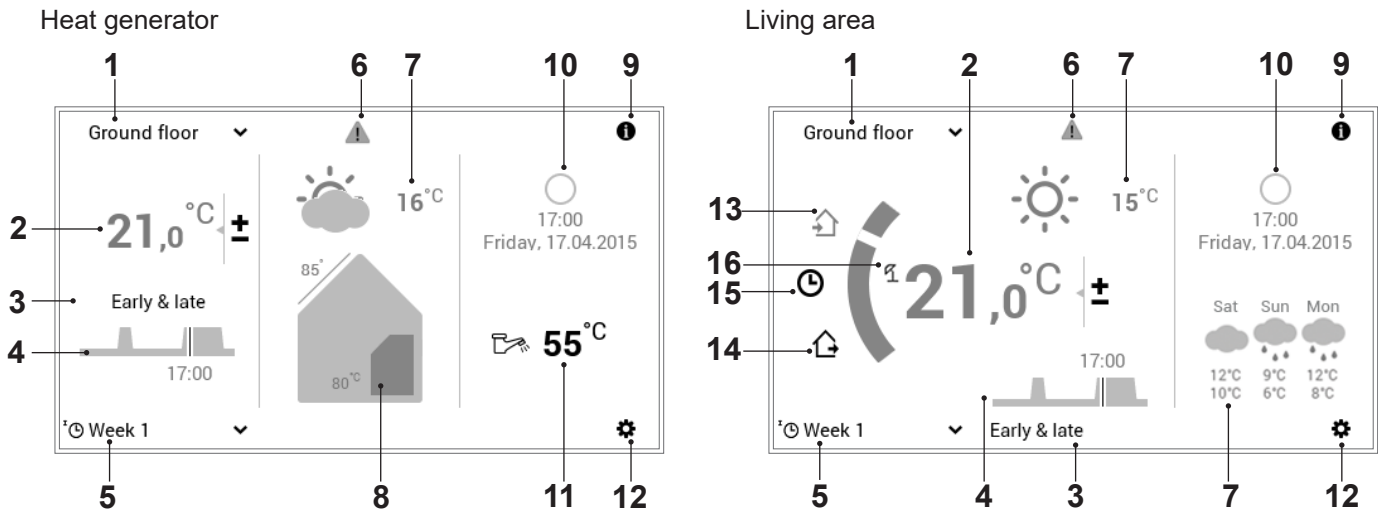







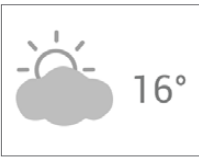
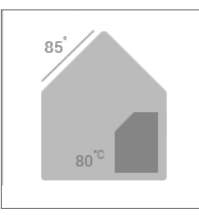

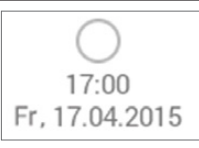

The display of the start screen is a standard view. The operating elements can be adapted by the user. Please check the start screen settings in 6.13.3 page 73 if the display is different.

6.6.1 Elements of the start screen heat generator and living area



Position / symbol	Designation	Function	Chapter / page
1	 Heating circuit	If a house is divided into individual heating areas, the heating circuit refers to each individually adjustable portion. Each heating circuit can have individual settings assigned to it, such as basic program, day and week program as well as room temperature. If no name is shown, then there is only one heating circuit.	6.7.3 page 24
	 Operation heating circuits	Display of the joint or individual operation of all heating and domestic hot water circuits.	
		Individual operation of every individual heating circuit	
		Joint operation of all heating circuits (temperature and programs identical)	
2	 Room temperature	Displaying the current room temperature – in room control modules and systems with room air sensor – in the selected heating circuit. Adaptation of the temperature by increasing or reducing the preset temperature (6.7.1 page 22). Display of the required room temperature in systems without room air sensor.	6.7.1 page 22
3	 Active day program	Currently active day program. Only displayed if the basic programs Week 1 and Week 2 (6.8 page 29) are selected.	6.7.5 page 25
4	 Switching cycle	The diagram shows the course of the day (room temperature vertical, time horizontal) of the active basic program or the assigned day program. The vertical line represents the current status.	6.10.5 page 46
5	 Basic program	Assignment of the basic program for the particular situation (e.g. week programs, Constant, Holiday). The basic program is used as the operating mode of the heating circuit.	6.7.4 page 24

6	 Information	Operating status	Currently active operating status	7.1 page 74
			 No display – correct operation	
		Alarm message display	 Warning Selection and display of alarm messages	
			 Information for the technician: Display authorisation level. If no level is displayed, the control is in level 0 - your operating level.	
7		Outside temperature	Display of the current outside temperature (only displayed if there is a outdoor temperature sensor). In addition, the phase of the moon is displayed at night. In connection with the TopTronic® E online, the current weather is displayed.	
8		Information active heat generator	Displays the current temperature in the active heat generator. If a solar plant is installed, the collector temperature is also displayed. If the heat generator/solar plant is currently active, this is indicated by an orange colour.	
9		Information	Detailed information about the system	6.7.7 page 28
10		Phase of the moon, time and date	Display of the current time and date. In connection with the TopTronic® E online, the current phase of the moon is displayed.	
11		Hot water	Shows the current domestic hot water temperature if necessary.	6.11 page 52
12		Main menu	This operating element accesses the main menu.	6.12.1 page 59
13		Day program	Heating takes place immediately, the «Party» program is activated.	6.10 page 41
14		Present	Used for quickly switching over if you will be absent for a few hours.	6.10.3 page 43
15		Week program	Back to the week program	6.7.4 page 24
16		Special symbols	 = summer mode  = frost protection when pump on  = screed drying	



The display of the start screen is a standard view. The operating elements can be adapted by the user. Please check the start screen settings in 6.13.3 page 73 if the display is different.

6.6.2 Optional start screen

The TopTronic® E control module includes five different displays of the start screen. Depending on the individual requirement, the required start screen can be defined during commissioning and set by the heating specialist.

 A subsequent changeover to one of the variants described below can only be made by the heating specialist.

Start screen Heat generator

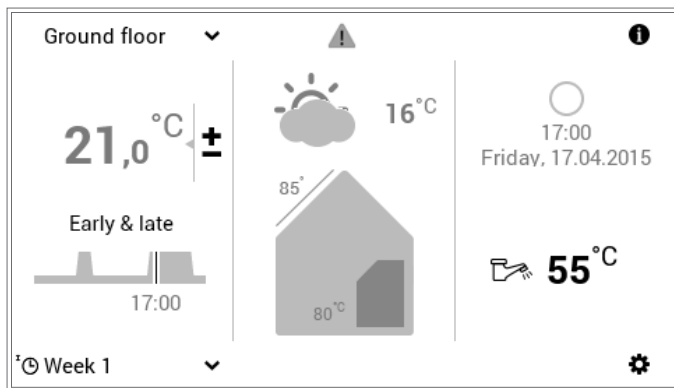

The heat generator screen shows detailed information about the heat generator. In connection with the Top-Tronic® E online, the weather forecast and the current phase of the moon are displayed.

Start screen Living comfort (option)

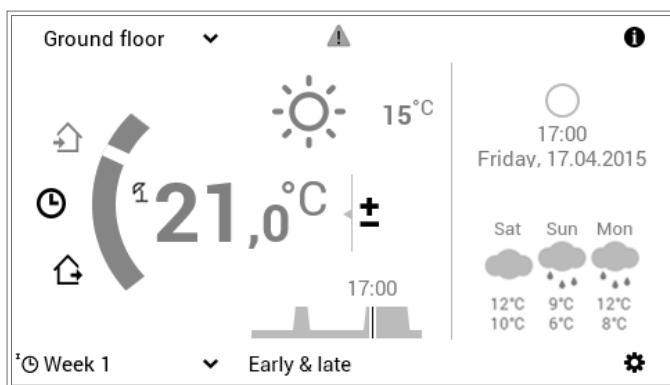

In contrast to the heat generator start screen, the “Living comfort” start screen focuses on quickly switching over between day programs (chapter 6.10 page 41) as well as absence (chapter 6.10.3 page 43). The information about heat generators is shown with a smaller size. In connection with the TopTronic® E online, the weather forecast and the current phase of the moon can also be displayed.

Start screen Living easy (option)

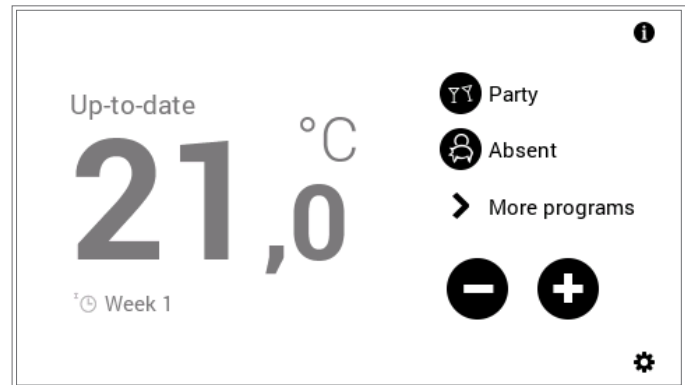

Please refer to the separate operating instructions for the room control module easy.

Start screen Industrial (option)

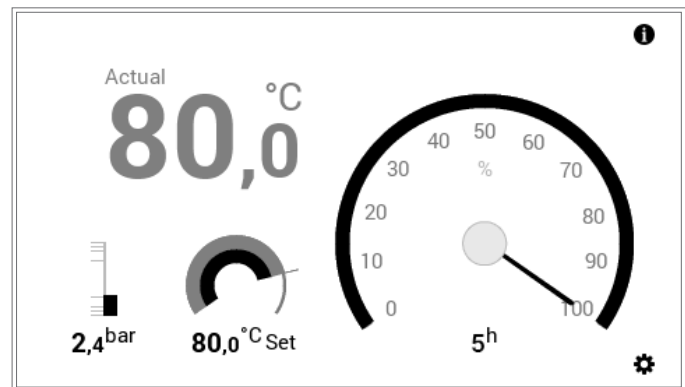

The start screen “Industrial” is usually used in large plants. As a result, only the current heat generator temperature, the water pressure (optional), the desired heat generator temperature, the operating hours and the output are displayed.

Start screen District heating (option)

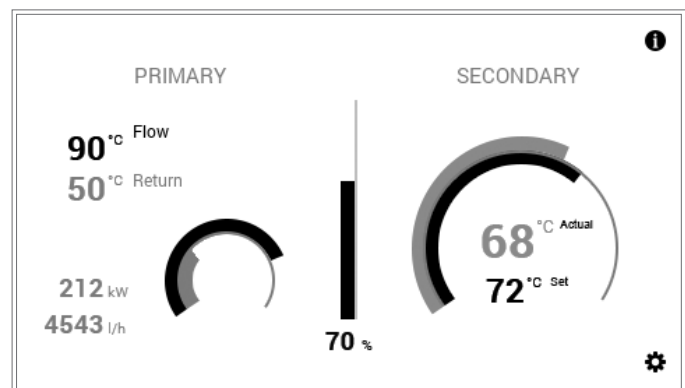

The current position of the primary valve in %, the temperature deviation between desired and current temperature in the graph and, optionally, the current absolute power are displayed.

Overview of control elements

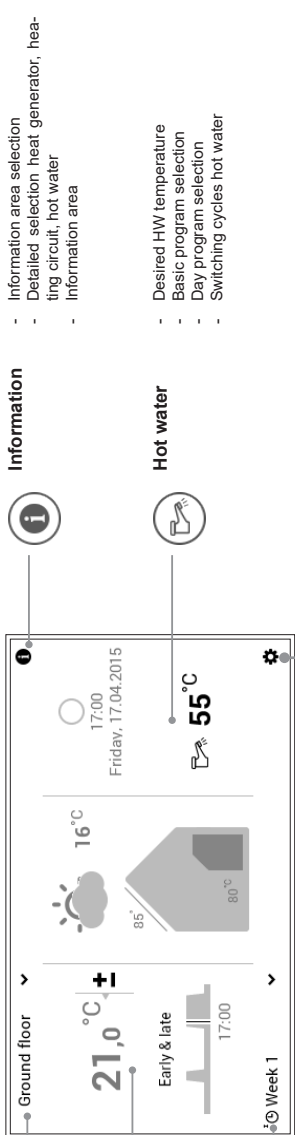

- Information**
- Information area selection
 - Detailed selection heat generator, heating circuit, hot water
 - Information area

- Hot water**
- Desired HW temperature
 - Basic program selection
 - Day program selection
 - Switching cycles hot water

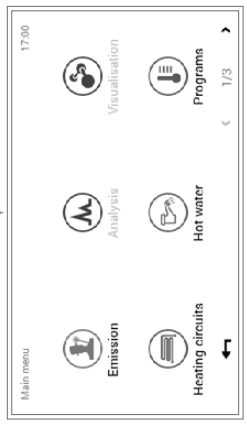

Page 1/3

	Emission	<ul style="list-style-type: none"> - Selection heat generator - Remaining run time - Output limitation - Information area
	Analysis	<ul style="list-style-type: none"> - Selection heat generator, heating circuit, hot water - Selection duration - Diagram display
	Visualisation	<ul style="list-style-type: none"> - For solar collector systems
	Heating circuits	<ul style="list-style-type: none"> - Desired room temperature - Basic program selection - Day program selection - Switching cycles room temperature
	Hot water	<ul style="list-style-type: none"> - Desired HW temperature - Basic program selection - Day program selection - Switching cycles hot water
	Programs	<ul style="list-style-type: none"> - Selection heating circuit/hot water - Detailed selection heating circuit/hot water - Adapting week programs - Adapting day programs

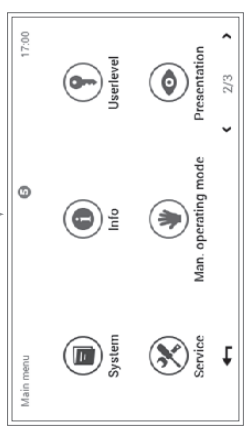

Page 2/3

	System	<ul style="list-style-type: none"> - Display of the next due maintenance/cleaning/service
	Info	<ul style="list-style-type: none"> - Information area selection - Detailed selection heat generator, heating circuit, hot water, solar, etc. - Information area
	User level	<ul style="list-style-type: none"> - User level PIN entry
	Service	<ul style="list-style-type: none"> - Menu item only for heating specialist
	Manual mode	<ul style="list-style-type: none"> - Selection heat generator/heating circuit - Detailed selection - Cooling operation/OFF/heating operation - Information
	Presentation	<ul style="list-style-type: none"> - Language - Colour scheme - Start screen - Backlighting - Duration until standby - Display until standby - Authorisation - Configuration analysis

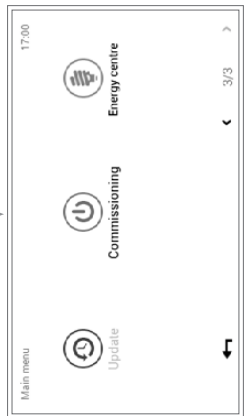

Page 3/3

	Commissioning	<ul style="list-style-type: none"> - Menu item only for heating specialist
	Update	<ul style="list-style-type: none"> - Menu item only for heating specialist
	Power station	<ul style="list-style-type: none"> - Influence of weather forecast on the heating. The function is only active with remote connection.

Functions might not be available for selection, depending on the version of your operating element.



6.7 Main settings

6.7.1 Changing the room temperature

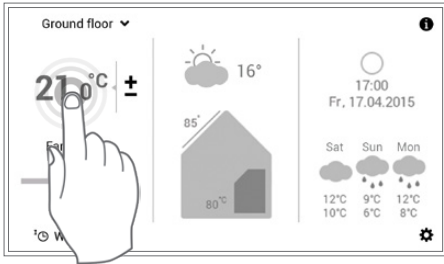

1 Touch the displayed room temperature to select it.

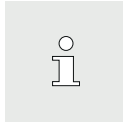

If there are several heating circuits, make sure that the correct heating circuit is displayed (example: ground floor). See “Selecting heating circuit” in chapter 6.7.3 page 24.

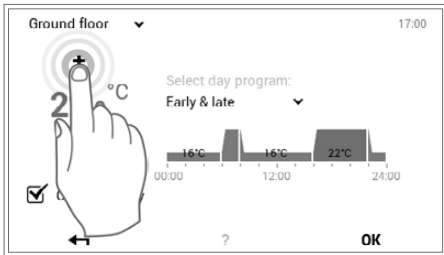

2 Touch the **plus (+)** or **minus (-)** button several times to set the required room temperature.

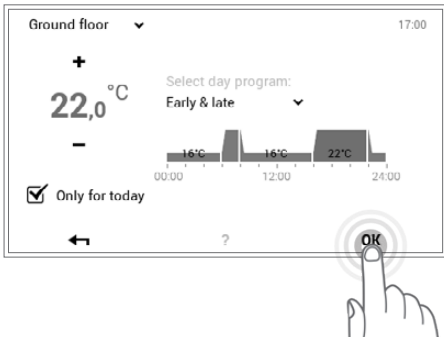

3 Accept the settings with **OK**.

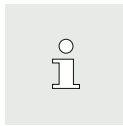

The room temperature is only accepted in the active day program up to the end of the current cycle. Deactivate the checkbox for “**Only for today**” to store the change in the active day program.



4 A change message is displayed. Confirm this with **OK**. Touch the **Back** (←) button if you want to edit the settings again.

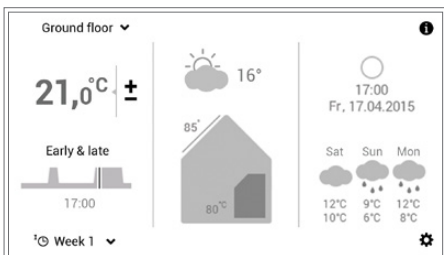

5 The current room temperature is displayed on the start screen and goes up or down until the desired room temperature is reached.

6.7.2 Adapt hot water temperature

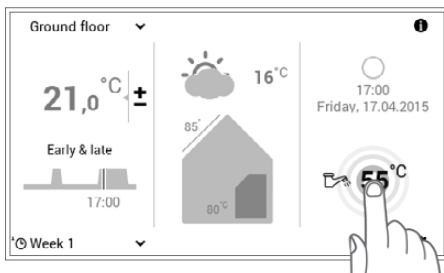

- 1 Touch the displayed **water temperature** to select it.

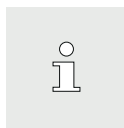

You can also access the function for setting the required water temperature using **Main menu** (⚙) > **Hot water** (6.12.1 page 59, no. 5).

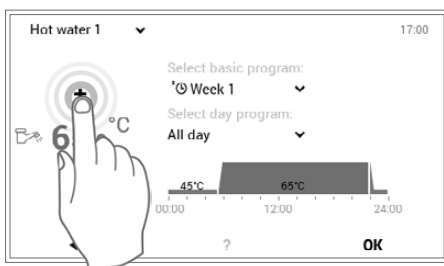

- 2 Touch the **plus (+)** or **minus (-)** button several times to set the required water temperature.

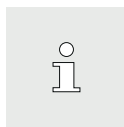

When a day program is active, the hot water temperature is only accepted in the active switching cycle.

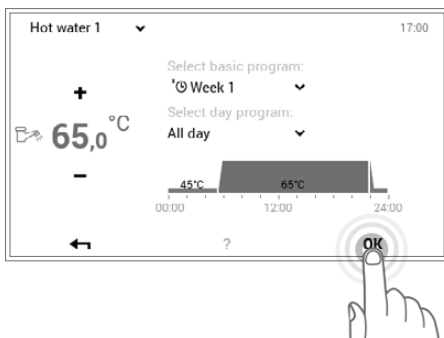

- 3 Accept the settings with **OK**.

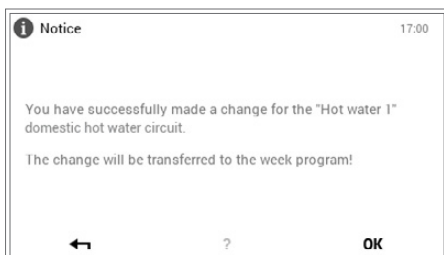

- 4 A change message is displayed. Confirm this with **OK**. Touch the Back (←) button if you want to edit the settings again.

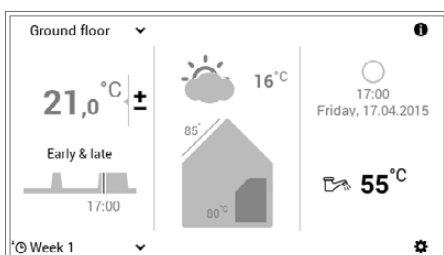

- 5 The current hot water temperature is displayed on the start screen and goes up or down until the desired water temperature is reached.

6.7.3 Select heating circuit (if there are several)

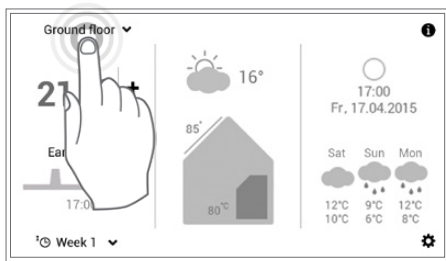

1 Touch the displayed **heating circuit** to select it (example: ground floor).

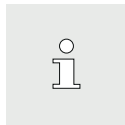

If your system only has one heating circuit, no heating circuit selection is displayed.

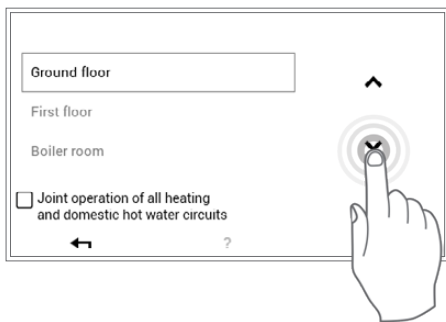

2 Use the **vertical arrows** (^▼) to select the required heating circuit and confirm with **OK**.

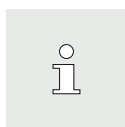

If there are several heating circuits (e.g. apartments), activating the **“Joint operation”** checkbox (6.7.8 page 28) allows all heating circuits to be controlled jointly. The room temperature, the day program and the basic program are thus changed at the same time in all circuits.

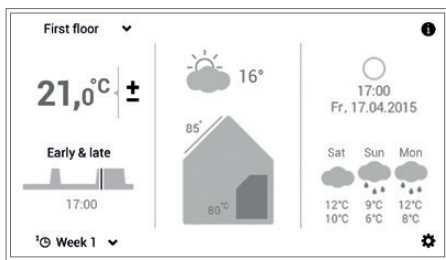

3 The selected heating circuit is displayed on the start screen. All settings in the left area of the control module are now accepted for this heating circuit.

6.7.4 Change the basic program (heating circuit)

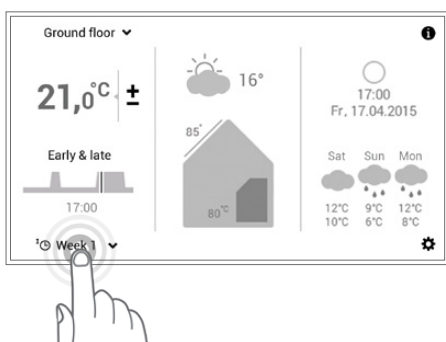

1 Touch the displayed **basic program** to select it (example: Week 1).

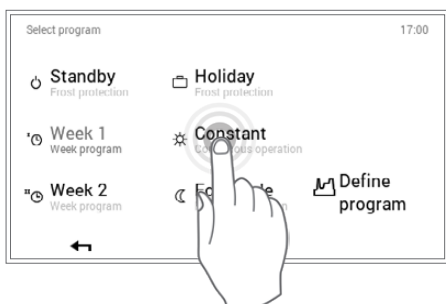

2 Select the desired **basic program**.

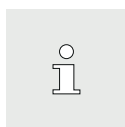

Individual basic programs additionally require the room temperature or the return date to be entered (6.8.2 page 30).



3 A change message is displayed. Confirm this with **OK**.

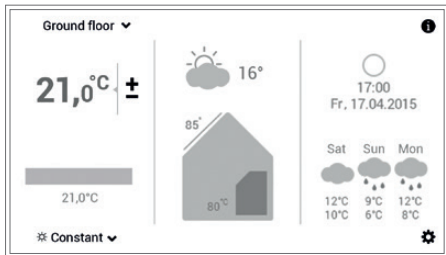

4 The new active basic program is displayed on the start screen.

6.7.5 Change active day program (heating circuit)

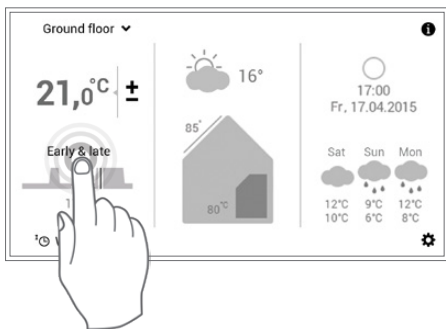

1 Touch the displayed **day program** to select it (example: early & late).

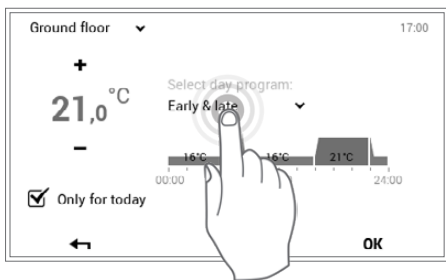

2 Touch the active **day program** to select it.



The adaptation to the day program is only accepted in the active week program for the current day. Deactivate the checkbox for **“Only for today”** to store the change in the week program.



3 Use the **vertical arrows** (^v) to select the required day program and confirm with **OK**.

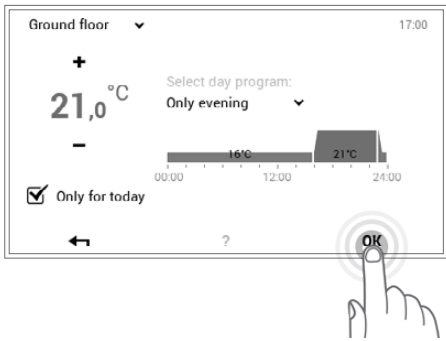

4 The selected day program is now displayed with the associated switching cycles as well as the room temperature.



The room temperature can be adapted again after the new desired day program has been selected.



5 A change message is displayed. Confirm this with **OK**. Touch the **Back** (←) button if you want to edit the settings again.

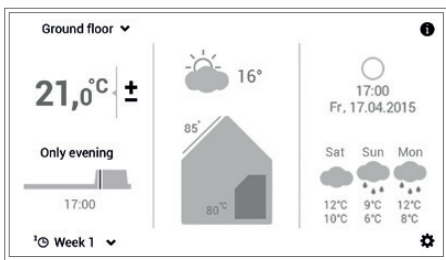

6 The new selected day program is displayed on the start screen.

6.7.6 Change basic and day program (hot water)

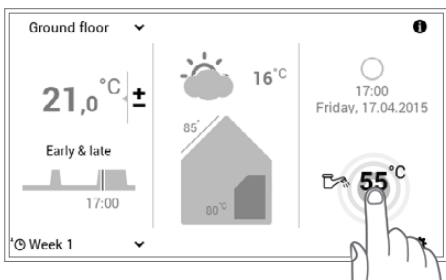

1 Touch the displayed **hot water temperature** to select it.

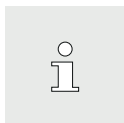

In connection with the TopTronic® E online, the weather forecast is displayed on your start screen as an option. You can also access the function for adapting the required water temperature using **Main menu > Hot water** (6.12.1 page 59).

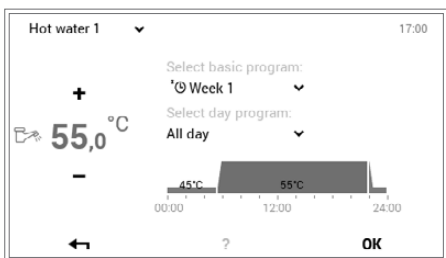

2 Touch the **hot water basic program** or **hot water day program** to select it.

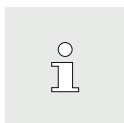

Hot water basic and day programs are independent from the heating circuit basic and day programs. The hot water basic program can be set to **Week 1**, for example, while the heating operation is heating with the **Constant** setting.

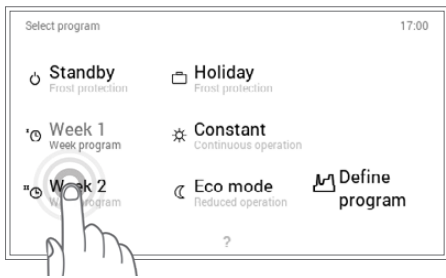

3 Select basic program:

Select the desired hot water basic program.



Select day program:

Use the vertical arrows (^v) to select the required hot water day program and confirm with OK.

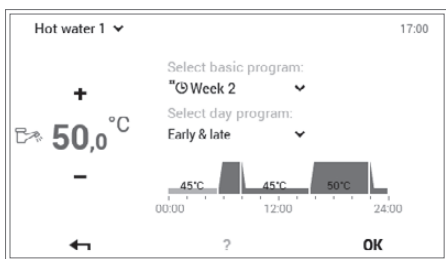

4 The selected basic or day program for water heating is displayed on the menu. Press OK to return to the start screen.

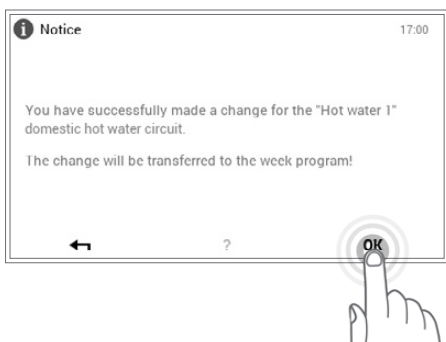

5 A change message is displayed. Confirm this with OK.

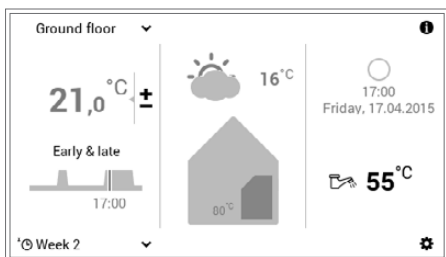

6 The current hot water temperature is displayed on the start screen and goes up or down until the water temperature of the selected basic or day program is reached.

With heat pumps:

 Under certain circumstances, at very low outside temperatures, it will not be possible to reach the required domestic hot water temperature or room temperature.

6.7.7 Call up system information

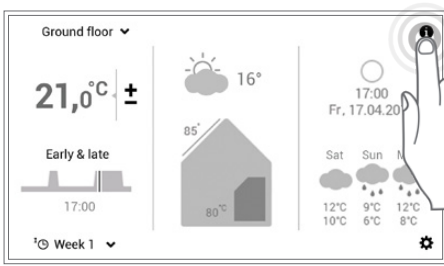

1 Touch the **Info** (i) button to select it.

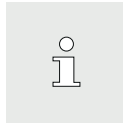

Also use the Main menu (⚙) > Info (page 2) to access the overview of the system information (6.12.2 page 60, no. 2).

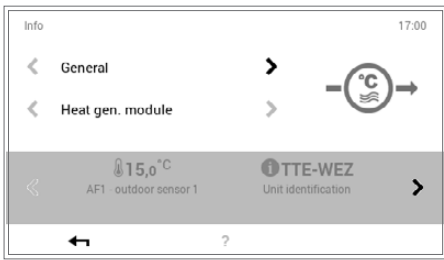

2 The Info menu item is displayed. Information for each system area can be called up here. To do this, use the horizontal arrows (◀ ▶) to select the corresponding areas. Use the Back (←) button to exit the menu item. The start screen appears again.

6.7.8 Joint operation for heating and domestic hot water circuits

If your system has several heating circuits (e.g. apartments), the TopTronic® E control module offers the “Joint operation of all heating and domestic hot water circuits” function. For the same operating mode to be set for all heating and hot water circuits (max. 28 circuits), it is necessary for the “Joint operation of all heating and domestic hot water circuits” checkbox to be activated (6.7.3 page 24, no. 2). The room temperature, the day program and the basic program are thus changed at the same time in all circuits.

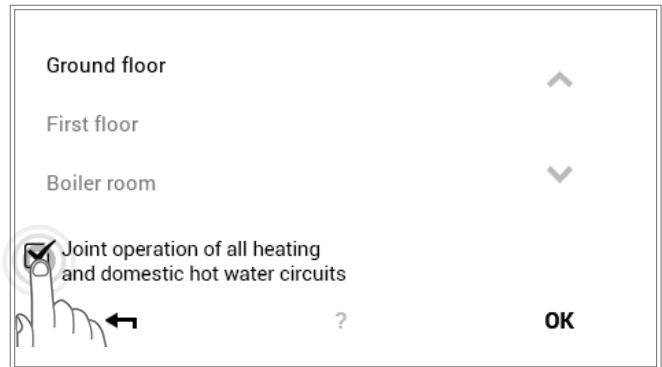

Programs are controlled as follows in joint operation:

<p>Temperature</p>	<p>Synchronisation exclusively in the heating circuits</p>  <p>There is <u>no</u> synchronisation of the hot water and the heating circuit temperatures during the joint operating.</p>
<p>Basic programs</p>	<p>Synchronisation in the heating and hot water circuits</p>
<p>Day programs</p>	<p>Synchronisation exclusively in the heating circuits</p>
<p>“Special day programs” (Party and Absent)</p>	<p>Synchronisation in the heating and hot water circuits</p>

6.8 Basic programs

Basic programs are referred to as the operating modes of the TopTronic® E control and, in contrast to the day programs (6.10 page 41), they are usually selected for a lengthy period of time. You can thus achieve targeted energy savings by deliberately selecting the right basic program.

The basic programs **Week 1** and **Week 2** are available for recurrent weekly rhythms. Here, you can plan your individual week(s) by allocating day programs (6.10 page 41) and regulate the heating operation specifically. In addition, for example, you can activate the **Standby** basic program if you will be absent for a relatively long period of time. The heating system consequently switches OFF and frost protection is activated. An overview of the functions of the basic programs is presented below.

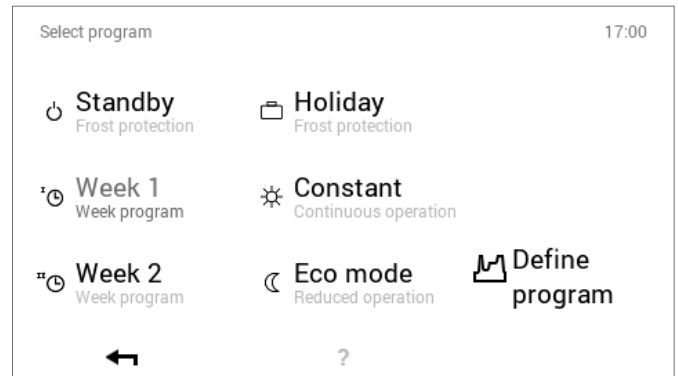





The TopTronic® E automatically switches to summer disconnection as the outside temperatures rise, thus saving energy. This function requires an outdoor sensor, however.



Refer to 6.7.4 page 24 for a detailed description of selecting basic programs.

6.8.1 Functions of the various basic programs

Basic program	Possible occasion and functions
 Week 1 Day programs	<p>You are at home all day, every day of the week.</p> <ul style="list-style-type: none"> • Heating operation defined by individual day programs • Hot water operation active in a separate basic program • In the standard program during the day continuous heating operation at 22 °C, at night reduced heating operation (16 °C). On Saturdays and Sundays, heating operation during the day at 22 °C and at night reduced heating operation (16 °C). • Mo – Su = heating “all day” • For more information about “Week 2”, see chapter 6.9 page 32
 Week 2 Day programs	<p>You go to work during the day from Monday to Friday, and are at home on Saturday and Sunday.</p> <ul style="list-style-type: none"> • Heating operation defined by individual day programs • Hot water operation active in a separate basic program • In the standard program mornings and evenings heating operation at 22 °C, during the day and at night reduced heating operation (16 °C). On Saturdays and Sundays, heating operation during the day at 22 °C and at night reduced heating operation (16 °C). • Mo – Fr = early & late / Sa and Su = all day • For more information about “Week 1”, see chapter 6.9 page 32
 Eco mode Reduced operation 	<p>You feel comfortable with a slightly lower temperature and you would like to save energy.</p> <ul style="list-style-type: none"> • Continuously reduced 24 h operation • Constant room temperature - optional • Hot water operation active in a separate basic program

 **Constant**
Continuous operation

You would like to heat the rooms during the night, too.

- Room temperature is not reduced during the night
- Constant room temperature - optional
- Hot water operation active in a separate basic program

 **Holiday**
Frost protection

You are going on holiday for e.g. 1 week and you know the date of your return.

- Heating system OFF
- No hot water operation
- Frost protection activated

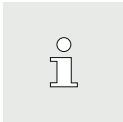

Start date holiday = heating OFF at 24:00
End date holiday = heating ON at 24:00
(to ensure your house is warm when you come home set the return date one day earlier)

 **Standby**
Frost protection

You are travelling for an indefinite period of time in spring or in autumn. It does not matter if the rooms are cold on your return. You do not need warm water on your return.

- Heating system OFF
- Frost protection active
- No hot water operation



If joint operating mode is not active, the “Standby” basic program only acts on the selected heating circuit!

6.8.2 “Holiday” – enter return date

Switching to the Holiday basic program additionally requires the return date to be entered for automatic resumption of heating operation. On the entered return date

(24:00 hours), the system switches back to the previously active basic program.

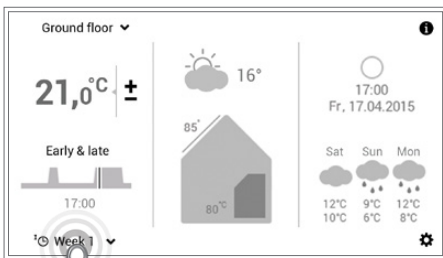

1 Touch the displayed **basic program** to select it (example: Week 1).

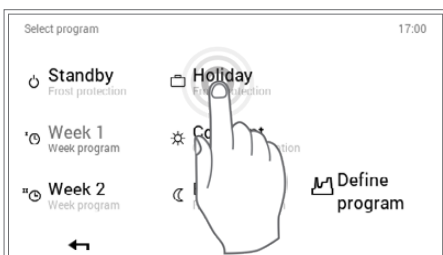

2 Select the **Holiday** basic program.

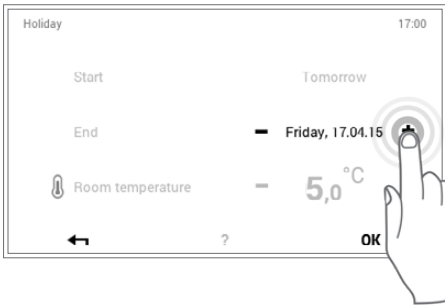

3 Touch the **plus (+)** button several times or select the **current date** to select the required return date (minus at least 1 day). Accept the settings with **OK**.

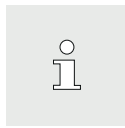

Start: the system is switched OFF at 0:00 hours (frost protection activated).



4 A change message is displayed. Confirm this with **OK**.

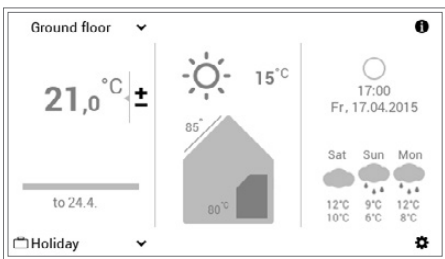

5 The newly selected basic program is displayed on the start screen.

6.9 Week programs

The **Week 1** and **Week 2** operating modes integrated in the basic programs are referred to as week programs. These enable you to plan your individual weekly rhythm (example: working week, early shift, late shift, etc.). To make the selection easier for you, it is possible to edit the names of the week program individually. In this case, each day of the week keeps its own day program with integrated switching cycles (6.10 page 41). You can also adapt these to your personal requirements and assign them to the week program.

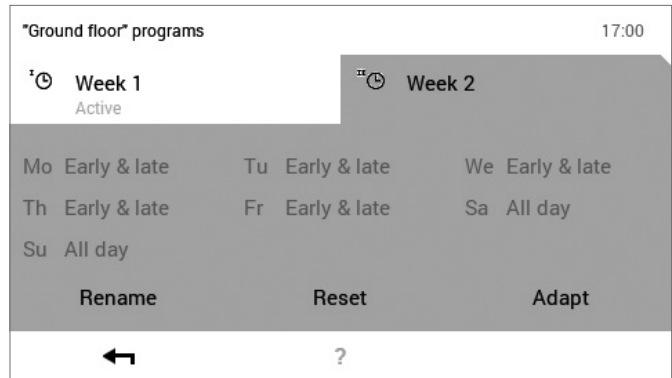

 Refer to 6.9.4 page 35 for a detailed description of editing the week programs.

6.9.1 Week program default settings

The predefined week programs (Week 1 and Week 2) are used as default settings and can be activated using the **Week 1** and **Week 2** basic programs as operating mode. They can be edited individually (6.9.4 page 35) and renamed (6.9.5 page 37). Changed week programs can be reset to the default settings (see below) (6.9.6 page 39).

 Resetting the week programs does not reset the day programs they include!

Week program default settings:

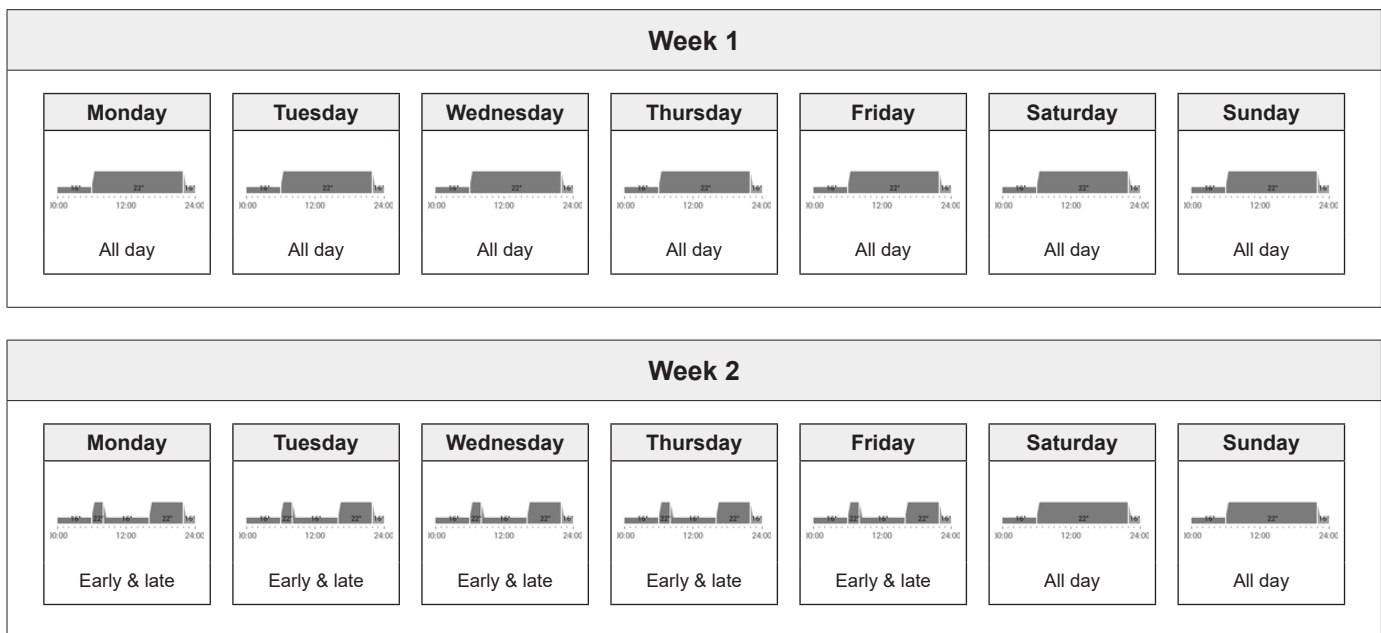

 Attention: Each heating circuit has two week programs. These can be composed of five different day programs (6.10 page 41). These day programs only apply in the particular heating circuit and are independent from the programs in other circuits!

6.9.2 Notes on personal week programs

For a clear display of the week programs that you have created, you will find two empty tables below in which you can record the day programs that you have stored.



For heating systems with several heating circuits, please make a copy of the empty tables.

Week program 1: _____						
Monday	Tuesday	Wednesday	Thursday	Friday	Saturday	Sunday
Day program:	Day program:	Day program:	Day program:	Day program:	Day program:	Day program:

Week program 2: _____						
Monday	Tuesday	Wednesday	Thursday	Friday	Saturday	Sunday
Day program:	Day program:	Day program:	Day program:	Day program:	Day program:	Day program:

6.9.3 Week program operating elements

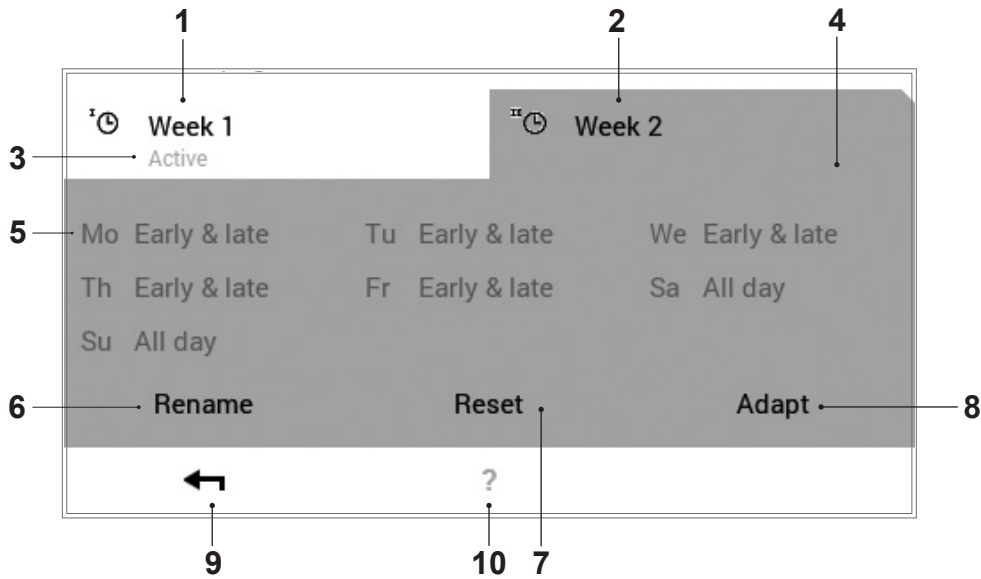

No.	Designation	Function
1	Week program 1	Heating program with individual week cycle 1
2	Week program 2	Heating program with individual week cycle 2
3	Active week program in heating circuit	Displays the active week program in the heating circuit. The message is not displayed if neither of the two week programs is operating.
4	For editing active week program	Marks the week program selected for editing (rename / reset / adapt).
5	Defined week cycle	Day programs assigned to the week days. The seven assigned day programs thus make up the week cycle or the week program.
6	Rename	Individual renaming of the selected week program (6.9.5 page 37)
7	Reset	Reset the selected week program to the default settings (6.9.6 page 39)
8	Adapt	Assignment of the day programs to the individual days of the week (6.9.4 page 35)
9	Back	Return (←) to the previous screen.
10	Help	Summarised information about the screen area shown above

 The illustrated screen is the standard view. Various elements can be renamed and adapted by the user in the menu.

6.9.4 Adapt week program

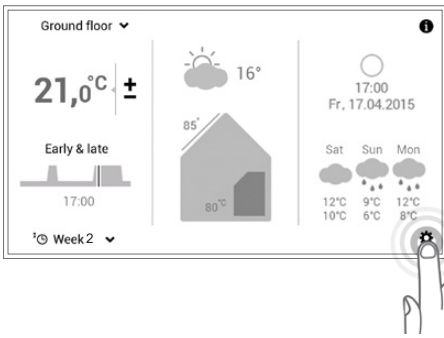

1 Touch the **Main menu** (⚙️) button to select it.



“Adapt week program” is also possible using Basic program > “Week2” > “Define program”.

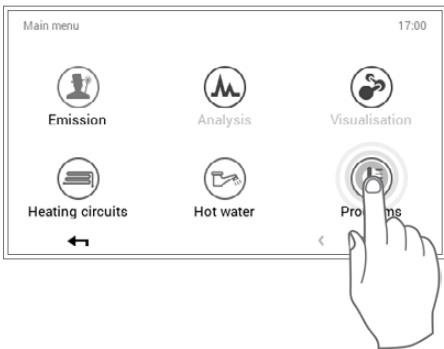

2 Touch the **Programs** button to select it.

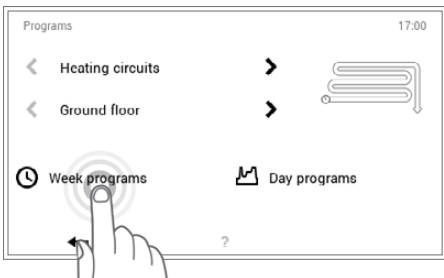

3 The overview for the heating circuit and the program selection appears. Select the required heating circuit and then **Week programs**.

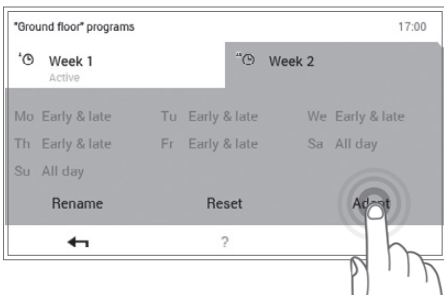

4 Select the required week program (example: Week 2). Touch the **Adapt** button to make settings in the selected week program.

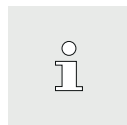

The names of the week programs (Week 1 and Week 2) may be different if they have already been changed.

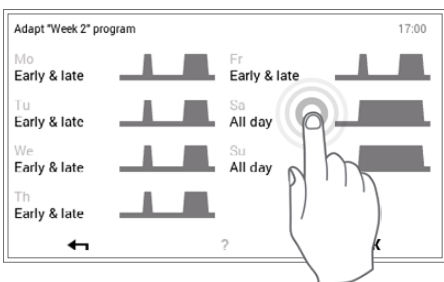

5 Select the required **week day** to assign a new day program to it.



6 Use the **vertical arrows** (^v) to select the new day program and confirm with **OK**.

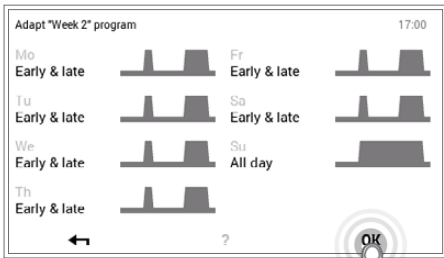

7 The overview of the selected week program opens again. Press **OK** to accept the adaptation.

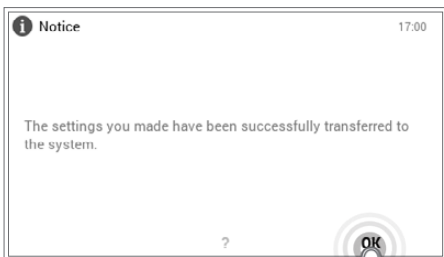

8 A change message is displayed. Confirm this with **OK**.

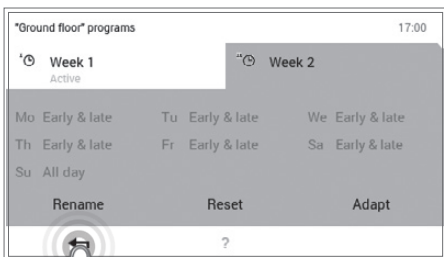

9 The adaptations are displayed in the selected week program. Press **Back** (←) to return to the menu item.

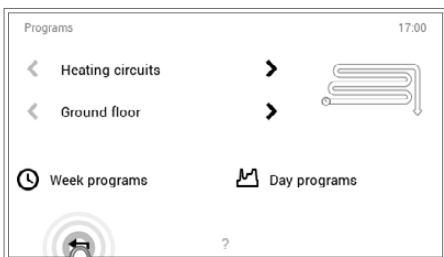

10 Touch **Back** (←) to close the **Programs** menu item.

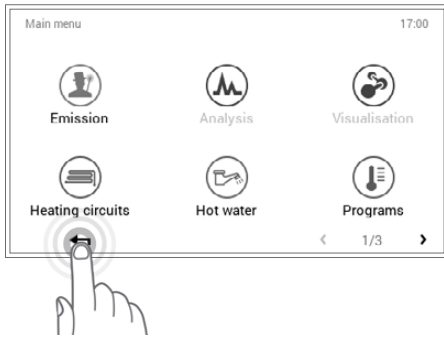

11 Select **Back** (←) again to close the main menu.

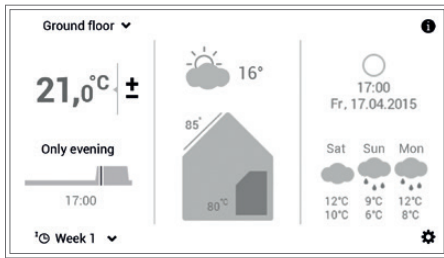

12 If the week program is active, the settings are displayed on the start screen.

6.9.5 Rename week program

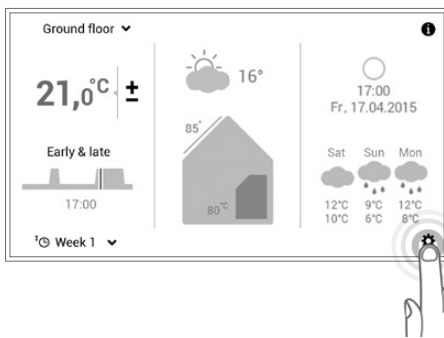

1 Touch the **Main menu** (⚙) button to select it.

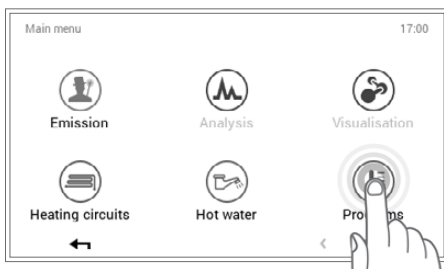

2 Touch the **Programs** button to select it.

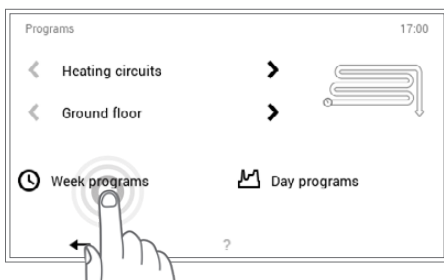

3 The overview for the heating circuit and the program selection appears. Select the required heating circuit and then **Week programs**.

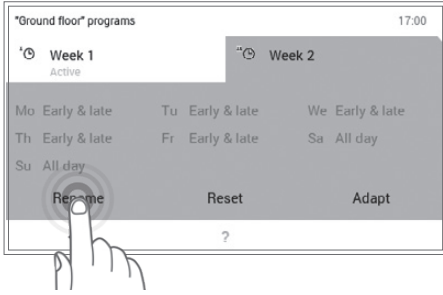

4 Select the required week program (example: Week 2). Touch the **Rename** button to select it.

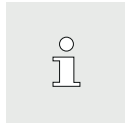

The names of the week programs (Week 1 and Week 2) may be different if they have already been changed.



5 A **keypad** appears on the screen that you can use for renaming the selected week program. Press **OK** to accept the entry.

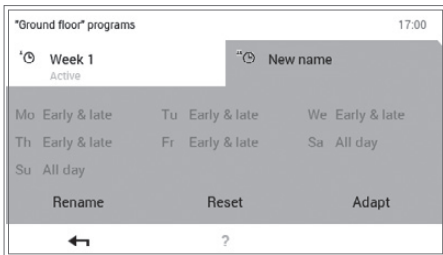

6 The new name is displayed in the selected week program. Press **OK** or **Back** (←) to return to the menu item.

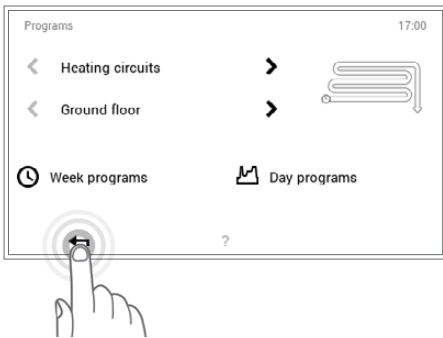

7 Touch **Back** (←) to close the **Programs** menu item.

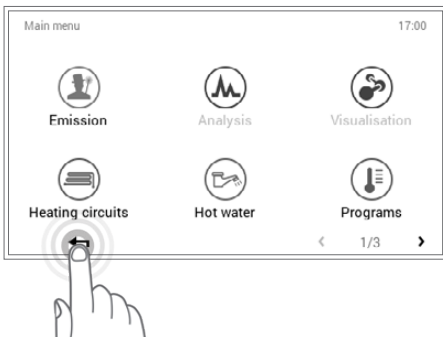

8 Select **Back** (←) again to close the main menu.

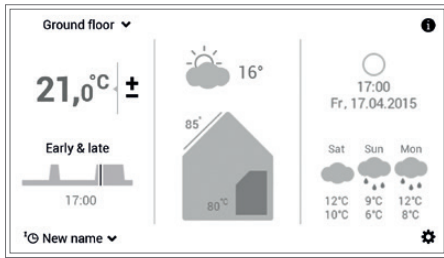

9 If the newly named week program is active as the basic program, the new name is displayed on the start screen.

6.9.6 Reset week program

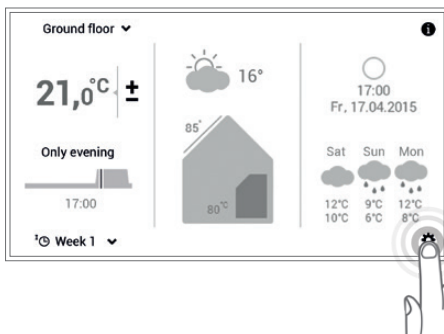

1 Touch the **Main menu** (⚙️) button to select it.

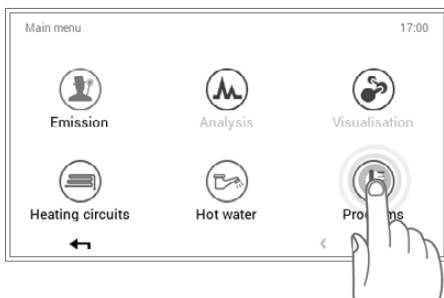

2 Touch the **Programs** button to select it.

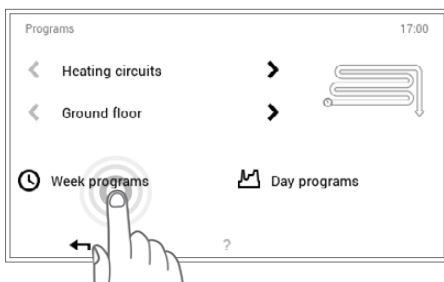

3 The overview for the heating circuit and the program selection appears. Select the required heating circuit and then **Week programs**.

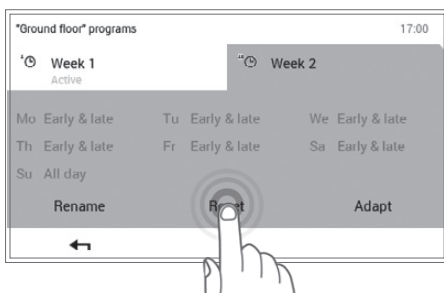

4 Select the required week program (example: Week 2). Touch the **Reset** button to reset the settings in the selected week program to their default values.



The names of the week programs (Week 1 and Week 2) may be different if they have already been changed.

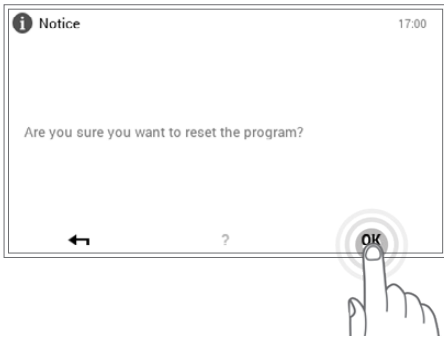

5 A confirmation message is displayed. Confirm this with **OK**. Press **Back** (←) to go back without resetting the program.

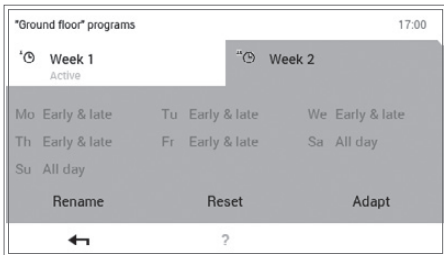

6 The pre-programmed standard program is displayed in the selected week program. Press **OK** or **Back** (←) to return to the menu item.

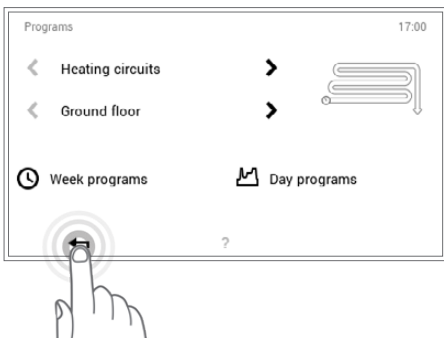

7 Touch **Back** (←) to close the **Programs** menu item.

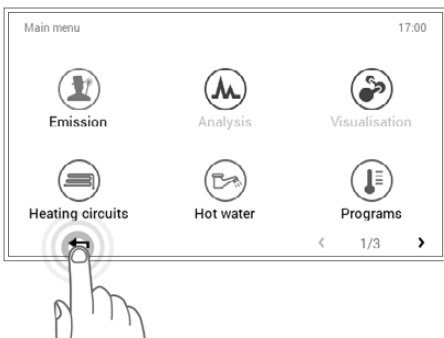

8 Select **Back** (←) again to close the main menu.

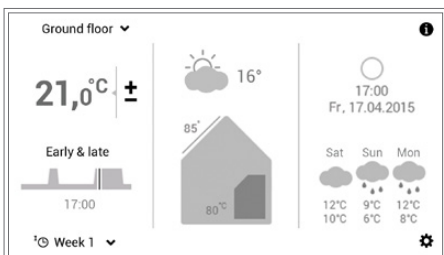

9 If the reset week program is active, the default settings are displayed on the start screen.

6.10 Day programs / switching cycles

Day programs are elements which are subordinate to the week program and contain what are referred to as switching cycles with corresponding room temperature specifications. You can adapt day programs and switching cycles to meet your particular requirements. Thus, for example, the heat output can be reduced for regular and recurrent periods of absence (e.g. working day) or the temperature can be specifically adapted for presences with different time periods.







- The heating circuit day programs/switching cycles are independent from the hot water day programs (6.11 page 52).
- The preset day programs with defined switching cycles can be adapted and renamed.
- The switching cycles of a day program are only active if the corresponding week program is selected as the basic program.
- A maximum of six switching cycles are possible for each day program.

6.10.1 Default settings for day programs / switching cycles

In the factory setting, the names and the switching cycles of the day programs are predefined. Two of these standard day programs (all day and early & late) are already assigned to both week programs **Week 1** and **Week 2**. If you adapt these two day programs to your individual requirements, you need to consider that both week programs are also changed (6.5 page 16). You can edit the default settings listed below as you require (6.10.5 page 46), rename them at any time (6.10.6 page 48) and reset to the default settings (6.10.7 page 50).

Default settings for day programs

Day programs	Switching cycle / temperature			Example
	from	to	°C	
All day 	00:00	06:00	16	I work at home and I am present all day.
	06:00	22:00	22	
	22:00	00:00	16	
Longer day 	00:00	06:00	16	I am at home all day and I go to bed later in the evening.
	06:00	23:00	22	
	23:00	00:00	16	
Early & late 	00:00	06:00	16	I go to work at 08:00 hours in the morning and I do not return home until 17:00 hours in the evening.
	06:00	08:00	22	
	08:00	16:00	16	
	16:00	22:00	22	
	22:00	00:00	16	
Only evening 	00:00	16:00	16	I do not need any heating in the morning before I set off to work. I get back home at 17:00 hours in the evening.
	16:00	23:00	22	
	23:00	00:00	16	

NEW



from	to	°C
00:00	06:00	16
06:00	08:00	22
08:00	16:00	16
16:00	22:00	22
22:00	00:00	16

I create my own day program and adapt the switching cycles individually to my requirements. I use the switching cycles of the "Early & late" day program as a template.

6.10.2 Notes on personal day programs

For a clear display of the day programs that you have created, you will find six tables below in which you can make a note of the stored switching cycles and temperature settings. Please remember that only six day pro-

grams can be recorded in the tables. For systems with several heating circuits, please make a copy of the empty tables.

Day program for living area (heating circuit):			
Name of day program	from	to	°C

Day program for living area (heating circuit):			
Name of day program	from	to	°C

Day program for living area (heating circuit):			
Name of day program	from	to	°C

Day program for living area (heating circuit):			
Name of day program	from	to	°C



Day program for living area (heating circuit):			
Name of day program	from	to	°C

Day program for living area (heating circuit):			
Name of day program	from	to	°C

6.10.3 Party and absent

On the TopTronic® E, the day program can be changed at any time when a week program is active (6.7.5 page 25). If you come home earlier, for example, you can immediately activate the heating with a suitable day pro-

gram. Furthermore, if you are going to have a party or if you will be absent for a short time, you can extend or reduce the heating time with the “Party” or “Absent” programs.

Day program	Possible occasion and function
 Party	<p>You have guests in the evening.</p> <ul style="list-style-type: none"> Continued heating operation at the entered room temperature until the end of the desired period of time (duration) The room temperature should not be lowered at the preset time (day program)
 Absent	<p>You leave home in the afternoon and will only come back late in the evening.</p> <ul style="list-style-type: none"> (Reduced) heating operation at the desired room temperature until the end of the entered period of time (duration) Calorifier frost protected (5 °C)

The two “Party” and “Absent” programs can be selected as follows:

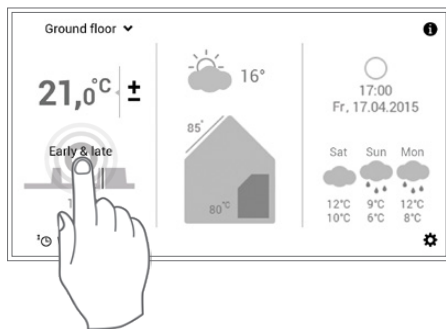

1 Touch the displayed **day program** to select it (example: early & late).

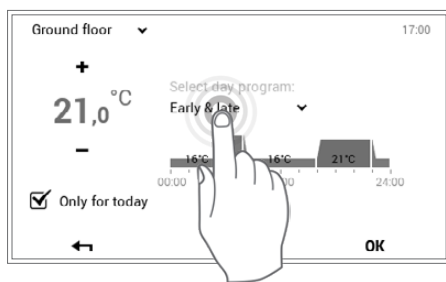

2 Touch the active **day program** to select it.



The adaptation to the day program is only accepted in the active week program for the current day. Deactivate the checkbox for “**Only for today**” to store the change in the week program.

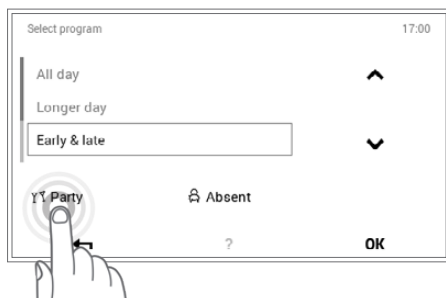

3 Select the desired program, **Party** or **Absent**.

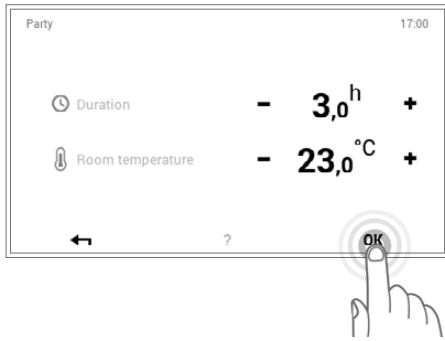

- 4 Press **plus (+)** and **minus (-)** to set the required duration and room temperature and confirm with **OK**.

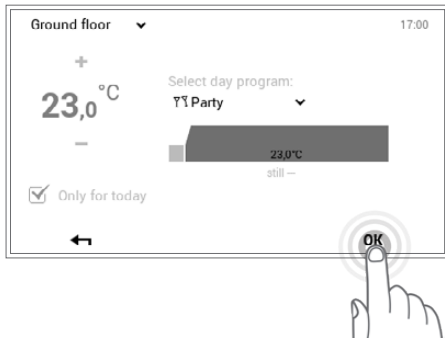

- 5 The active day program and the set room temperature can be seen on the screen. Accept the setting with **OK**.

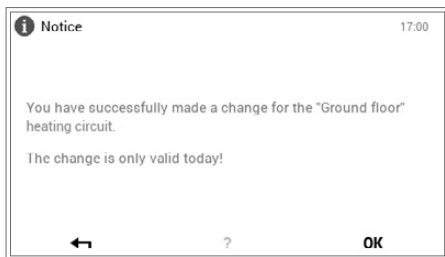

- 6 A change message is displayed. Confirm this with **OK**. Touch the **Back** (←) button if you want to edit the settings again.

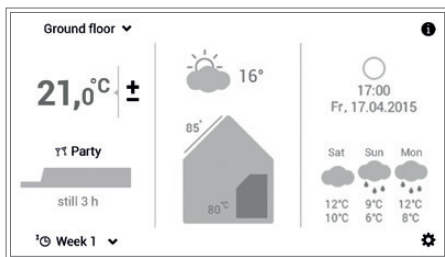

- 7 The new selected day program (Party) is displayed on the start screen.



“Party” and “Absent” are special day programs and cannot be included in week programs.

6.10.4 Day program / switching cycles operating elements

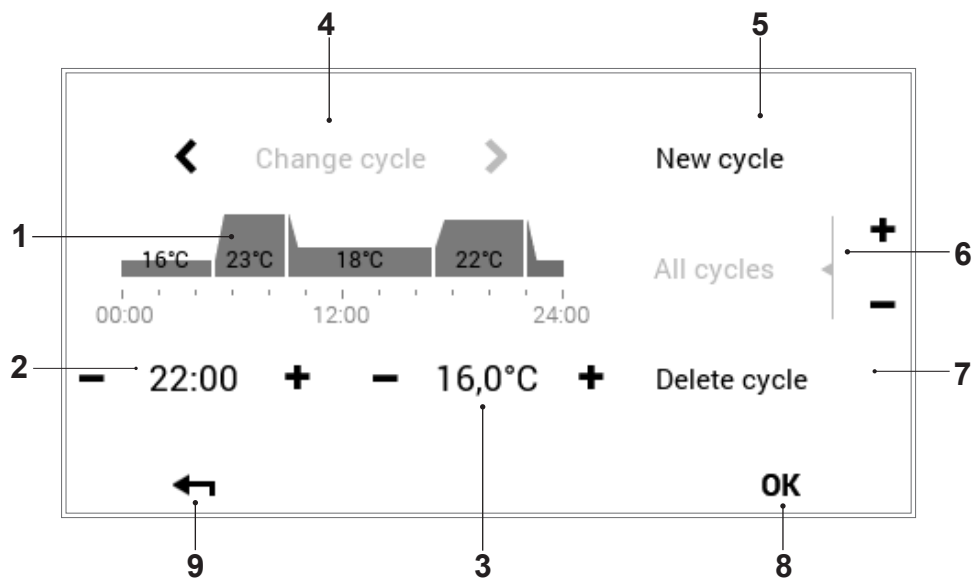

No.	Designation	Function
1	Day program / switching cycles	For adapting the selected day program with time cycles and corresponding temperature specifications. The time period marked in yellow shows the cycle that is active during the editing. The horizontal arrows (◀ ▶) are used for selecting the required period of time. Alternatively, the switching cycle to be edited can also be touched directly.
2	Start time – active cycle	Displays the start time of the selected cycle. Changes can be made to the start time using plus (+) and minus (-).
3	Temperature – active cycle	Represents the room temperature defined in the cycle. The temperature can be changed in the active cycle with plus (+) and minus (-).
4	Change cycle	Switch the cycle to be edited to the left or right. Alternatively, the switching cycle to be edited can also be touched directly.
5	New cycle	Create a new time cycle. The new cycle is added at the end of the day program.
6	All cycles	Increase or reduce the temperature of all cycles with plus (+) and minus (-) in the complete day program.
7	Delete cycle	Remove the selected cycle.
8	OK	Save (OK) the changes in the selected day program and return to the previous screen.
9	Back	Return (←) to the previous screen.

6.10.5 Change room temperatures and switching cycles in the day program

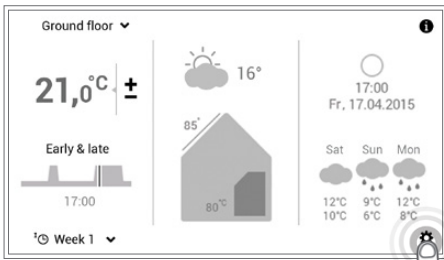

1 Touch the **Main menu** (⚙️) button to select it.

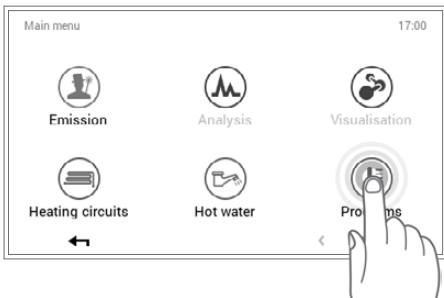

2 Touch the **Programs** button to select it.

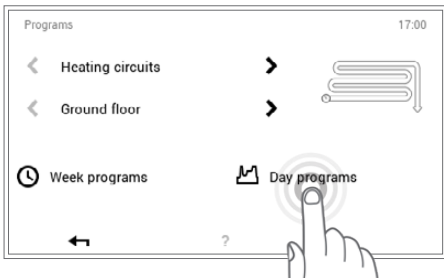

3 The overview for the heating circuit and the program selection appears. Select the required heating circuit and then **Day programs**.

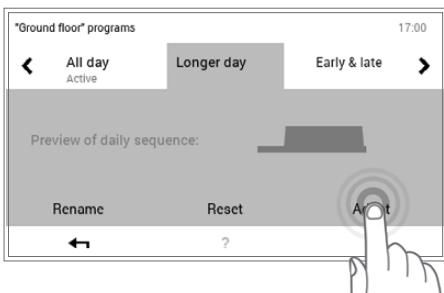

4 Select the desired day program (example: longer day) with the **horizontal arrows** (◀ ▶). Touch the **Adapt** button to make settings in the selected day program.

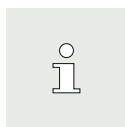

The names of the day programs may be different if they have already been changed.

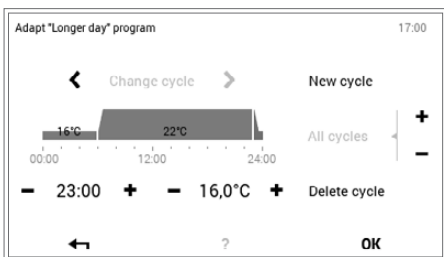

5 The overview of the selected day program is opened. Various adaptations can be made to the selected day program/switching cycle using **plus** (+) and **minus** (-). Press **OK** to accept the entry.



Refer to 6.10.4 page 45 for a detailed description of the day program overview.



6 A change message is displayed. Confirm this with **OK**.

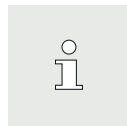

The change now acts both in week program 1 and in week program 2 (on all days of the week to which the changed day program is assigned).

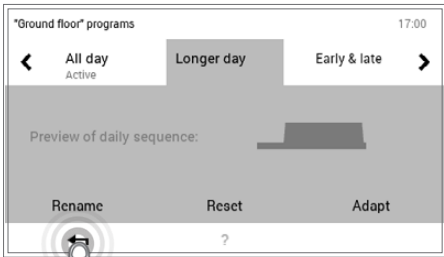

7 The adaptations are displayed in the selected day program. Press **Back** (←) to return to the menu item.

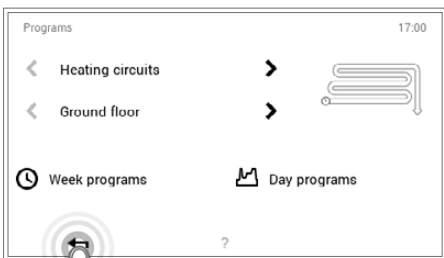

8 Touch **Back** (←) to close the **Programs** menu item.

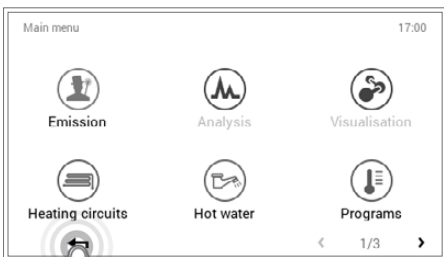

9 Select **Back** (←) again to close the main menu.

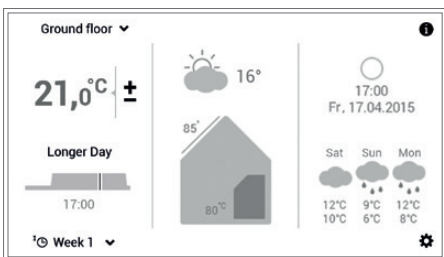

10 If the edited day program is active, the settings are displayed on the start screen.

6.10.6 Rename day program

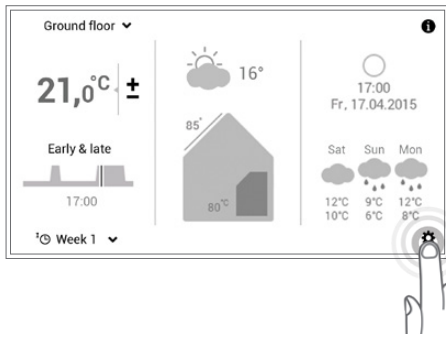

1 Touch the **Main menu** (⚙️) button to select it.

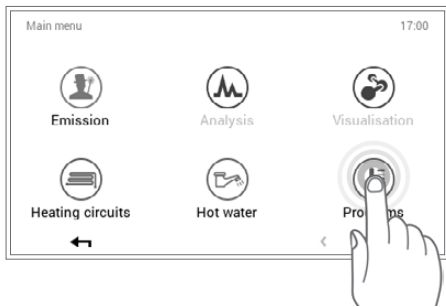

2 Touch the **Programs** button to select it.

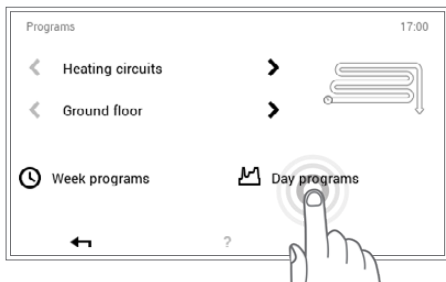

3 The overview for the heating circuit and the program selection appears. Select the required heating circuit and then **Day programs**.

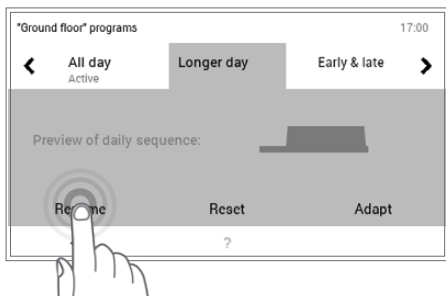

4 Select the desired day program (example: longer day) with the horizontal arrows (◀ ▶). Touch the **Rename** button to select it.

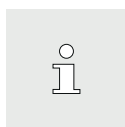

The names of the day programs may be different if they have already been changed.



5 A keypad appears on the screen that you can use for renaming the selected day program. Press **OK** to accept the entry.

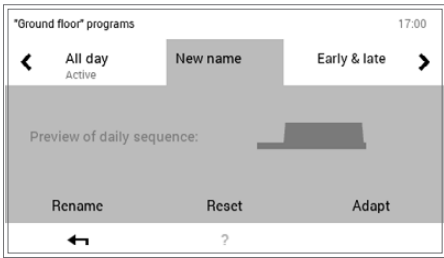

6 The new name is displayed in the selected day program. Press **Back** (←) to return to the menu item.

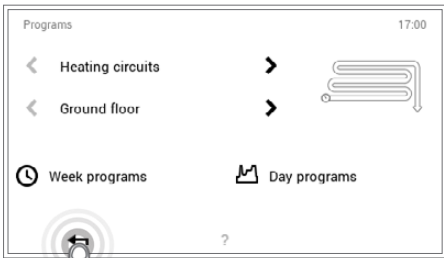

7 Touch **Back** (←) to close the **Programs** menu item.

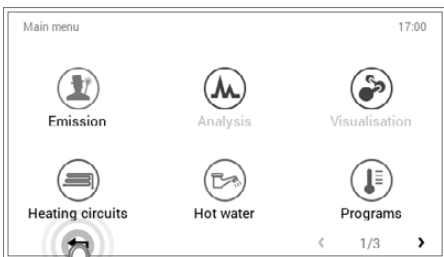

8 Select **Back** (←) again to close the main menu.

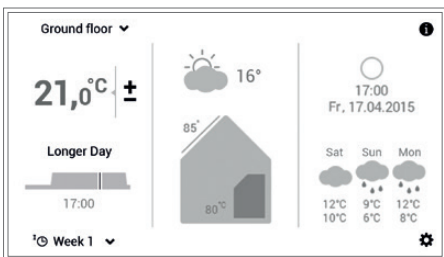

9 If the newly named day program is active as the basic program, the new name is displayed on the start screen.

6.10.7 Reset day program

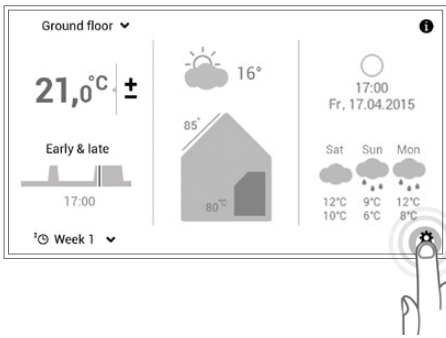

1 Touch the **Main menu** (⚙️) button to select it.

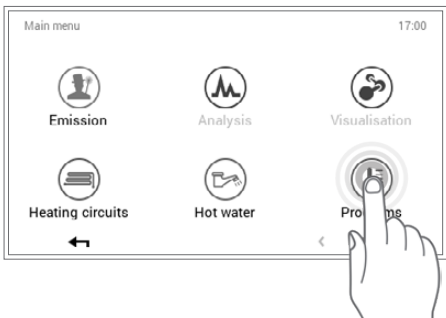

2 Touch the **Programs** button to select it.

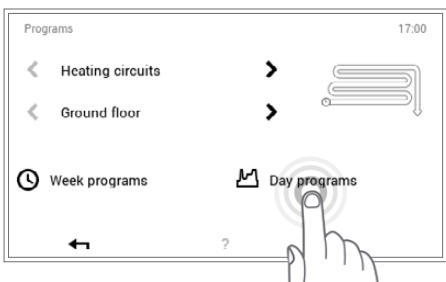

3 The overview for the heating circuit and the program selection appears. Select the required heating circuit and then **Day programs**.

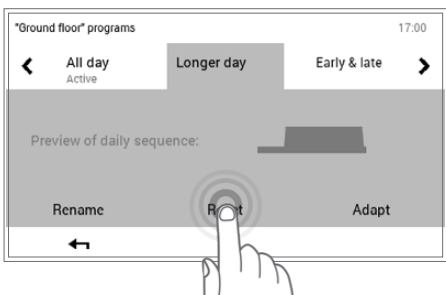

4 Select the desired day program (example: longer day) with the **horizontal arrows** (◀ ▶). Touch the **Reset** button to reset the settings in the selected day program to their default values.

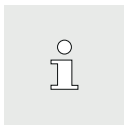

The names of the day programs may be different if they have already been changed.

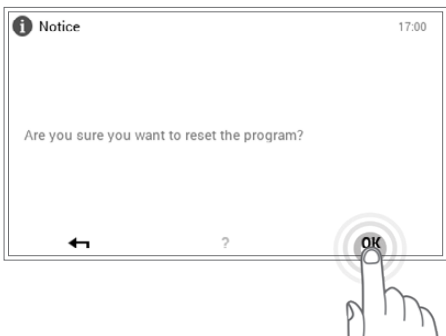

5 A confirmation message is displayed. Confirm this with **OK**. Press **Back** (◀) to go back without resetting the program.

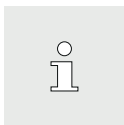

The name, the switching cycles as well as the required room temperatures of the day program are reset to the factory setting. If the reset day program is used in the week program, the factory setting is also active for this.

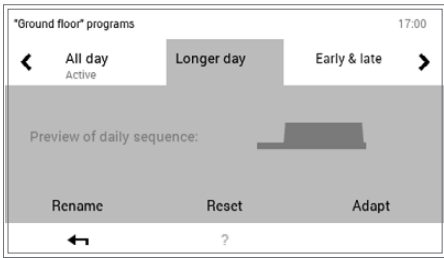

6 The pre-programmed standard program is displayed in the selected day program. Press **Back** (←) to return to the menu item.

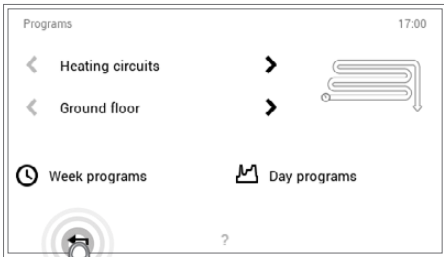

7 Touch **Back** (←) to close the **Programs** menu item.

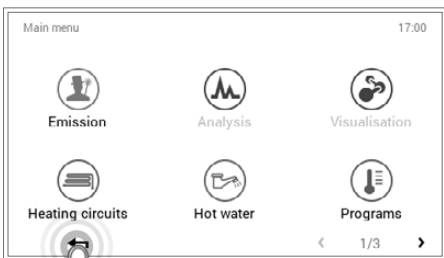

8 Select **Back** (←) again to close the main menu.

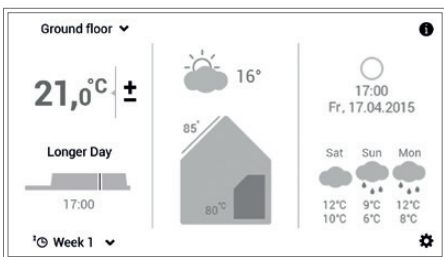

9 If the reset day program is active, the default settings are displayed on the start screen.

6.11 Hot water

Like in the area of the heating circuits, it is also possible to work with basic, week and day programs for hot water. The hot water programs that can be selected are independent from the heating circuit. Bear in mind that you have to activate each of the basic, week and day programs of the hot water separately (6.7.6 page 26) and edit them (6.12.6 page 64, no. 1).

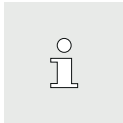

There is no synchronisation of the hot water temperature during the joint operating mode (6.7.8 page 28).

6.11.1 Hot water operating elements

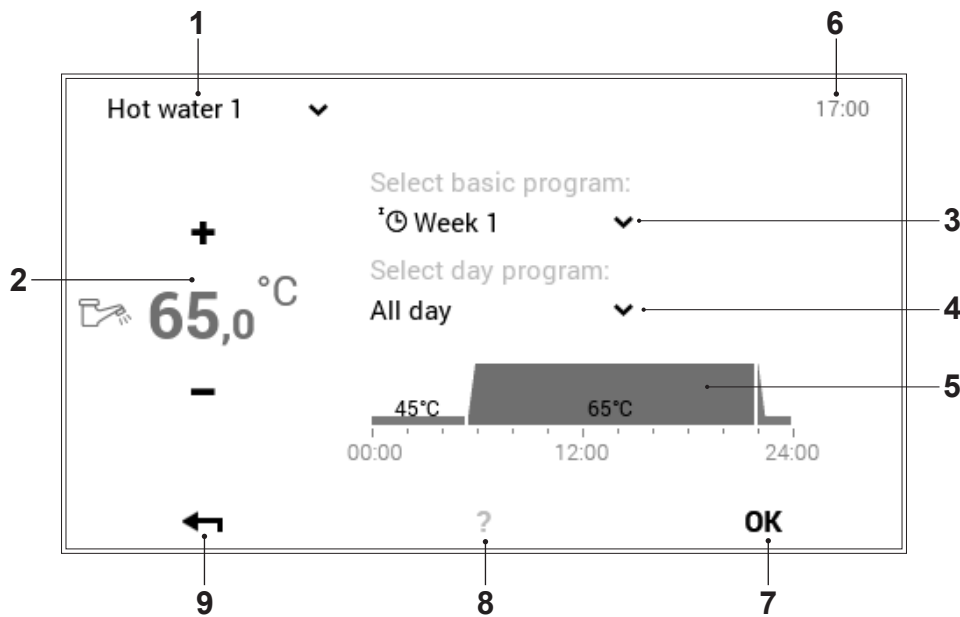

No.	Designation	Function
1	Hot water circuit	Display of the hot water circuit to be edited. Changes to the menu item are only stored in the selected hot water circuit. Use the down arrow (▼) to switch to another hot water circuit in the heating system.
2	Hot water temperature	Represents the hot water temperature desired in the particular switching cycle. The hot water temperature can be changed in the active switching cycle using plus (+) and minus (-). (→ page 27)
3	Basic program	Selection of the basic program. Use the down arrow (▼) to select a new program for editing.
4	Day program	Active day program in the week program. Use the down arrow (▼) to change the day program.
5	Switching cycles	Graphical display of the currently selected day program with all time cycles and corresponding temperature specifications. The time period marked in yellow shows the active cycle in which the water temperature can be changed with plus (+) and minus (-).
6	Time of day	Displays the current time.
7	OK	Save (OK) the changes in the selected hot water circuit and return to the previous screen
8	Help	No function is available at present
9	Back	Used as a button (←) for returning to the main menu.

6.11.2 Week programs – hot water

As well as the week and day programs for the heating cycles, the TopTronic® E control module includes additional week and day programs for water heating. The structure of the programs and the functions are identical.

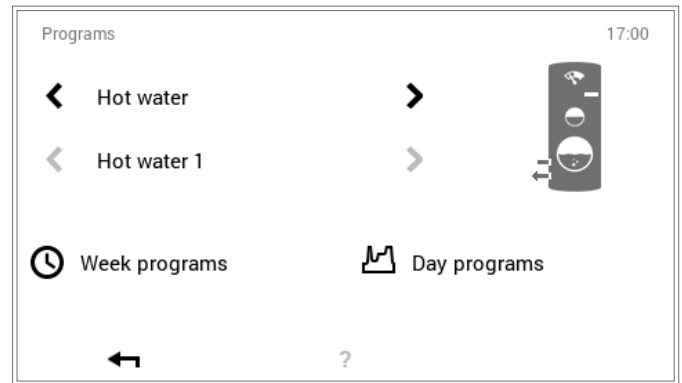

 The settings can be made using **Main menu (⚙) > Programs**. For a detailed description, refer to 6.12.6 page 64, no. 1.

6.11.3 Week program default settings – hot water

The following week programs are used as default settings and can be activated with **Main menu (⚙) > Hot water**. The two week programs can be individually edited (6.12.6 page 64), renamed (6.12.6 page 64) and reset (6.12.6 page 64).

 Resetting the week programs does not reset the day programs they include!

Week program default settings – hot water:

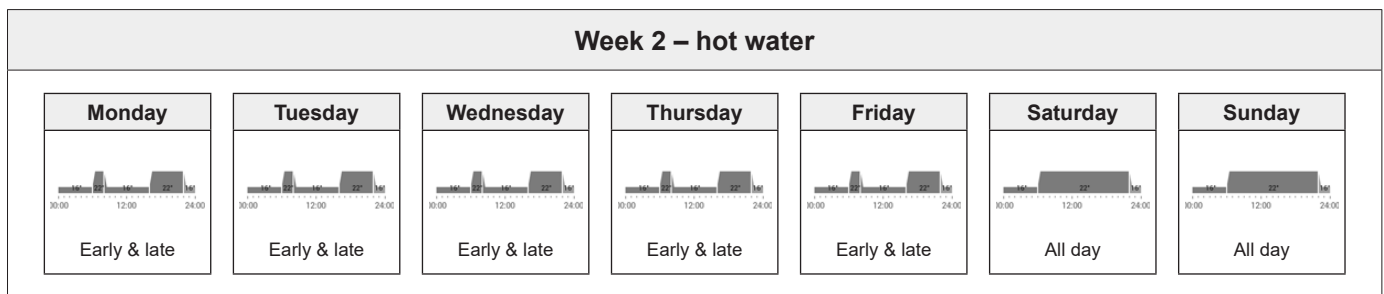
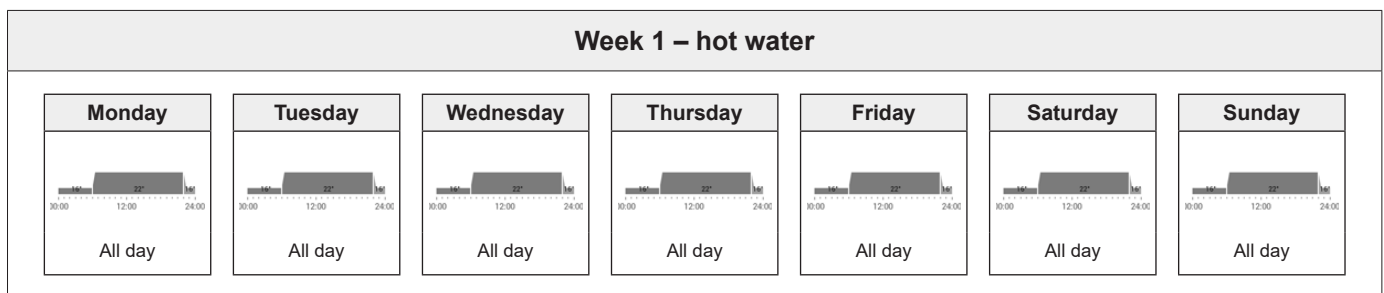

 Attention: Each hot water circuit has two week programs. These can be composed of five different day programs (6.11.4 page 54). These day programs only apply in the particular hot water circuit and are independent from the programs in other circuits!

6.11.4 Day programs / switching cycles for hot water

You can adapt the hot water day programs and switching cycles to your individual requirements and, in this way, control the water heating specifically for the required time period and hot water temperature if you use the hot water on a regular basis, for example.







- The hot water day programs/switching cycles are independent from the heating circuit day programs (6.10 page 41).
- The preset day programs with defined switching cycles can be adapted and renamed.
- The switching cycles of a day program are only active if the corresponding week program is selected as the basic program.
- A maximum of six switching cycles are possible for each day program.

6.11.5 Default settings for day programs / switching cycles – hot water

In the factory setting, the names and the switching cycles of the hot water day programs are predefined as with the heating circuits. Two of these standard day programs (all day and early & late) are assigned to both week programs **Week 1** and **Week 2**. If you adapt these two day programs to your individual requirements, you need to consider that both week programs are also changed (6.11.2 page 53). You can edit the default settings listed below as you require (6.12.6 page 64), rename them at any time (6.12.6 page 64) and reset to the default settings (6.12.6 page 64).

Default settings for day programs – hot water:

Day programs	Switching cycle / temperature			Example
	from	to	°C	
All day 	00:00	06:00	45	I work at home and I am present all day.
	05:30	22:00	50	
	22:00	00:00	45	
Early & late 	00:00	05:30	45	I go to work at 08:00 hours in the morning and I do not return home until 17:00 hours in the evening.
	05:30	08:00	50	
	08:00	15:30	45	
	15:30	22:00	50	
	22:00	00:00	45	
Only evening 	00:00	15:30	45	I do not need any hot water in the morning before I set off to work. I get back home at 17:00 hours in the evening.
	15:30	22:00	50	
	22:00	00:00	45	
All day legio 	00:00	05:30	45	I work at home and I am present all day. In addition, the legionella function is active (6.11.6 page 55).
	05:30	15:30	50	
	15:30	16:30	60	
	16:30	22:00	50	
	22:00	00:00	45	

NEW



from	to	°C
00:00	05:30	45
05:30	08:00	50
08:00	15:30	45
15:30	22:00	50
22:00	00:00	45

I create my own day program and adapt the switching cycles individually to my requirements. I use the switching cycles of the "Early & late" day program as a template.

6.11.6 Legionella function

Legionella are bacteria that can cause Legionnaire's disease. The optimum conditions for these bacteria to exist are hot water that is kept between 25 and 50 °C for long periods. Legionella are killed off when the full content of the water tank is heated through to 60 °C. The TopTronic® E control module includes a separate hot water day program (all day legio) that can be activated once a week in the week program.

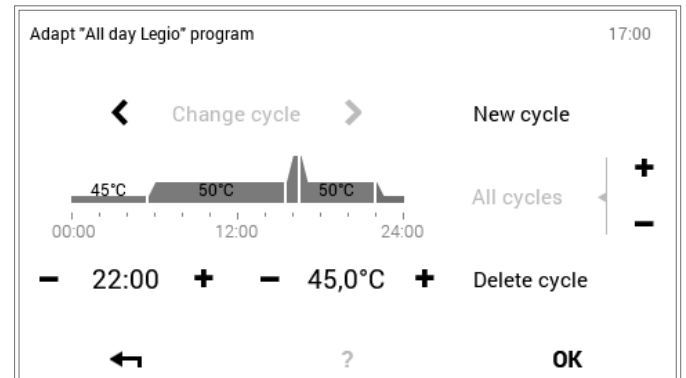

The legionella function can be activated in the **Main menu** (⚙) > **Programs** (6.12.6 page 64) by allocating the "all day legio" day program in the week program.

6.11.7 Recharging hot water

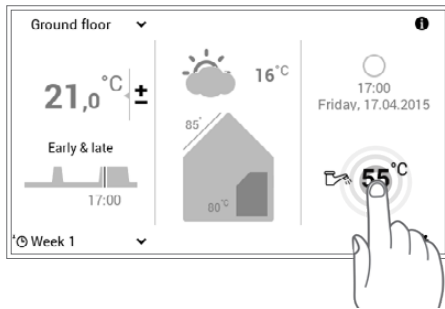

- 1 Touch the displayed water temperature to select it.



In connection with the TopTronic® E online, the weather forecast is displayed on your start screen as an option. You can also access the function for adapting the required water temperature using **Main menu > Hot water** (6.12.1 page 59).

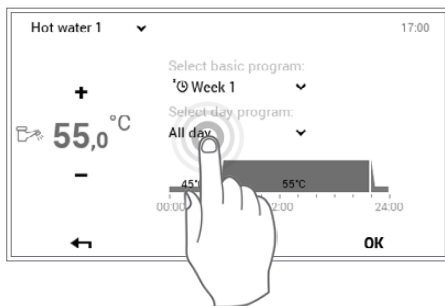

- 2 Touch the active **hot water day program** to select it.



The hot water day program is independent from the heating circuit day program. For example, it can be set to “early & late” while the heating operation is running with “all day”.

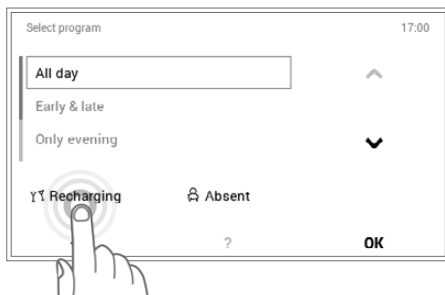

- 3 In the program selection, select the **Recharging** button.



With “Recharging”, it is possible to heat additional hot water. The duration and the hot water temperature can be set individually.

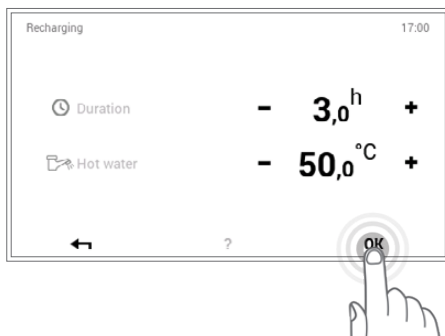

- 4 Press plus (+) and minus (–) to set the required duration and water temperature for recharging. Press **OK** to accept the settings.

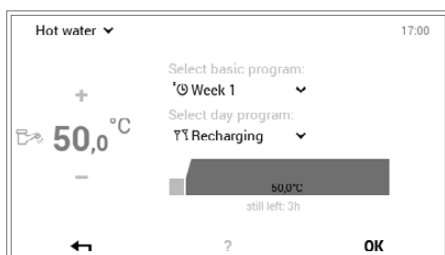

- 5 Hot water recharging is shown in the menu. Confirm the entries with **OK**.



6 A confirmation message is displayed. Confirm this with **OK**. Touch the **Back** (←) button if you want to edit the settings again.

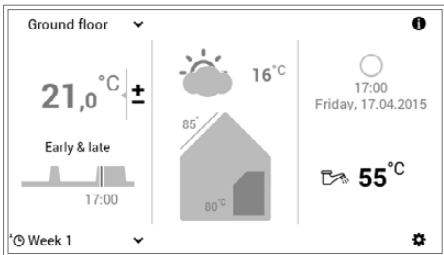

7 The current hot water temperature is displayed on the start screen and goes up or down until the desired water temperature of the recharging is reached.

6.11.8 Set hot water program to absent

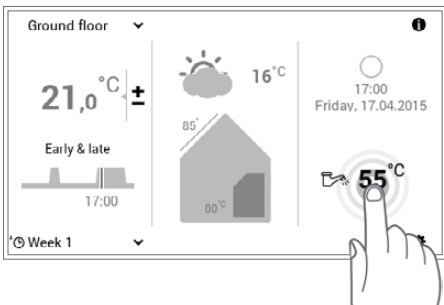

1 Touch the displayed **hot water temperature** to select it.



In connection with the TopTronic® E online, the weather forecast is displayed on your start screen as an option. You can also access the function for adapting the required water temperature using **Main menu > Hot water** (6.12.1 page 59).

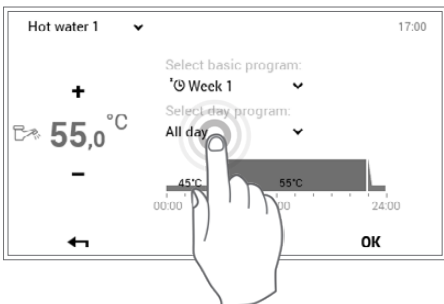

2 Touch the active **hot water day program** to select it.



The hot water day program is independent from the heating circuit day program. For example, it can be set to “all day” while the heating operation is running with “early & late”.

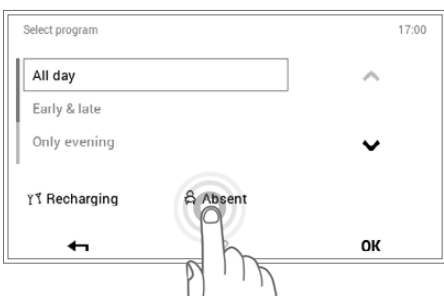

3 In the program selection, select the **Absent** button.

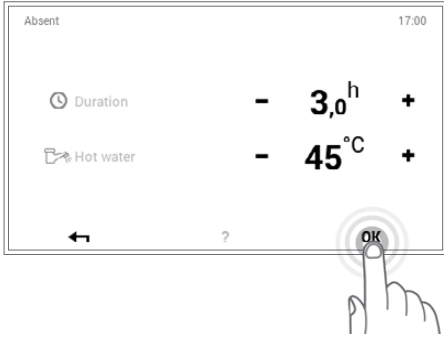

4 Press plus (+) and minus (-) to set the required duration of the absence as well as the desired water temperature. Press **OK** to accept the settings.

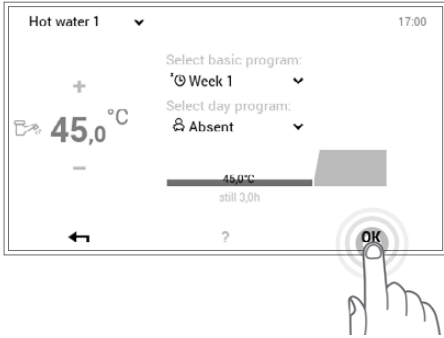

5 **Absent** is shown in the menu. Confirm the entries with **OK**.

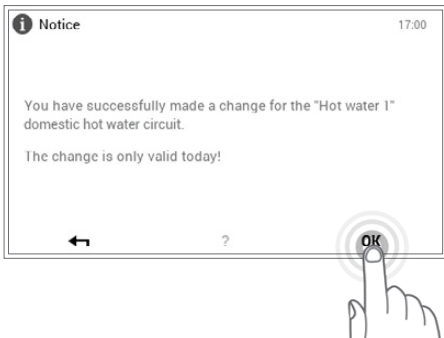

6 A confirmation message is displayed. Confirm this with **OK**. Touch the **Back** (←) button if you want to edit the settings again.

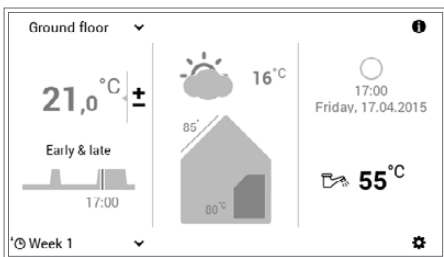

7 The current hot water temperature is displayed on the start screen and goes up or down until the desired water temperature for the absence is reached.

6.12 Other operating elements

6.12.1 Main menu view 1

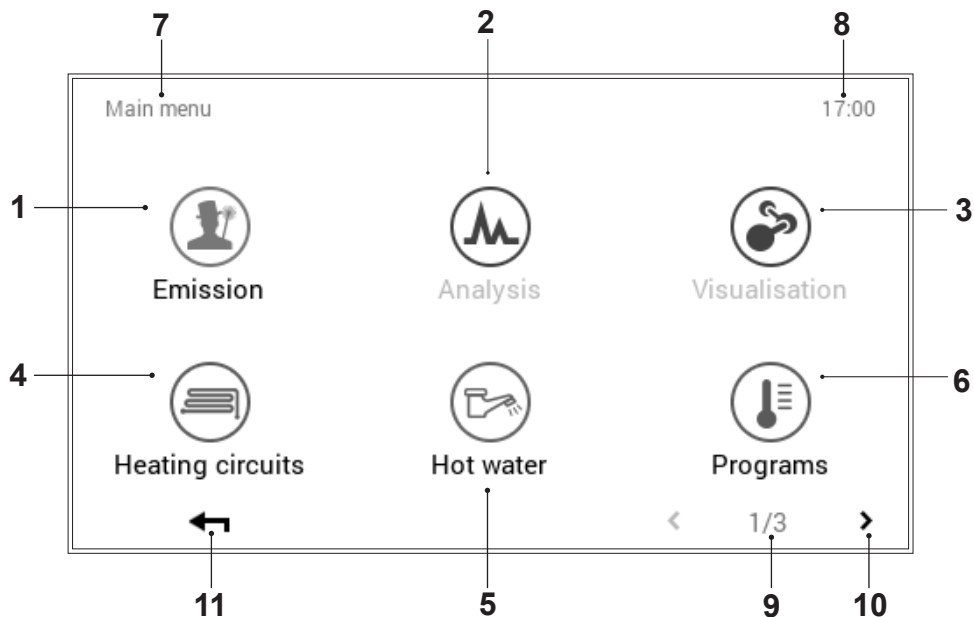

No.	Designation	Function
1	Emission metering	For heating specialist: setting the emission output limitation
2	Analysis	See 6.12.12 page 70
3	Visualisation	For heating specialist: not available with all heat generators
4	Heating circuits	Display and editing possibility of the selected heating circuit. Depending on the structure of the system, it is possible to select between one or more heating circuits. Information about the active operating and day program (6.12.7 page 65)
5	Hot water	Display and editing possibility of the selected hot water circuit. Depending on the structure of the system, it is also possible to select between one or more domestic hot water circuits in the hot water area. Specifications regarding an active operating and day program with adapted hot water temperature (6.11.1 page 52)
6	Programs	Menu item for adapting week and day programs in the selected heating or hot water circuit (6.12.6 page 64)
7	Position in the menu	Name of the currently selected menu item
8	Time of day	Displays the current time.
9	Page in the main menu	Display of the active main menu page (1)
10	Scroll	Arrow (➤) for navigating from main menu page 1 to main menu page 2
11	Back	Used as a button (↶) for returning to the start screen.



Individual menu items are active or inactive depending on the type of control module.

6.12.2 Main menu view 2

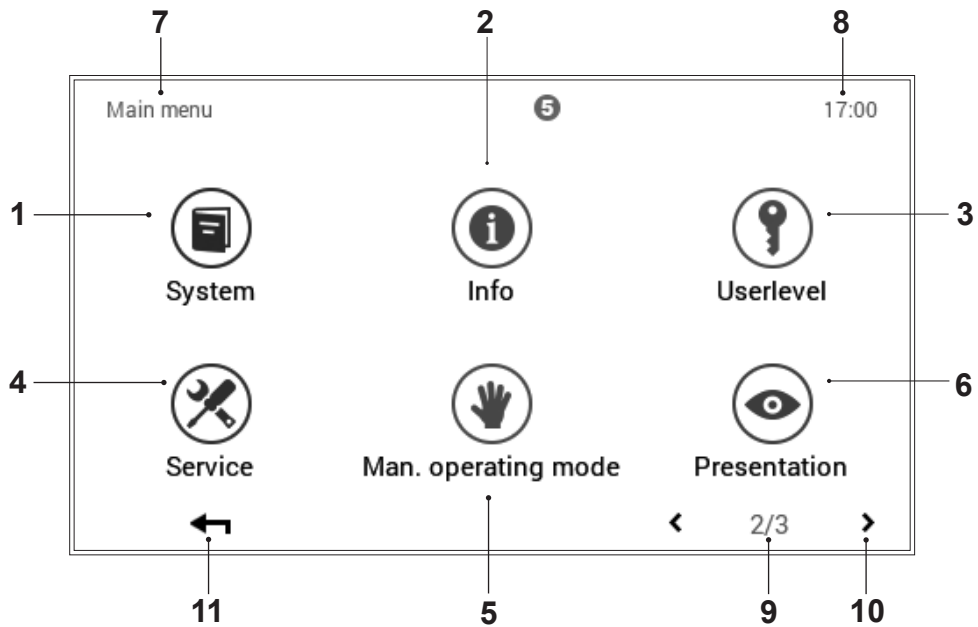

No.	Designation	Function
1	System	Provides information about maintenance, service and cleaning of the system.
2	Info	Display of various information about the system regarding the heat generator, heating circuit, hot water and solar. Bear in mind that a system may include several heat generators and heating or hot water circuits (6.12.8 page 66).
3	User level / authorisation level	For heating specialist: Releasing the authorisation level by entering the particular password
4	Service	For heating specialist: menu item for making adaptations to system settings
5	Manual mode	The heat generators, heating circuits and hot water circuits in the heating system can be operated manually at an adjustable temperature (6.12.11 page 69).
6	Presentation	Changing the current language, changing the colour scheme, adapting the start screen as well as various other settings (6.12.12 page 70, 6.12.13 page 71)
7	Position in the menu	Name of the currently selected menu item
8	Time of day	Displays the current time.
9	Page in the main menu	Display of the active main menu page (2)
10	Scroll	Arrow (< >) for navigating to main menu page 1 (left arrow) and main menu page 3 (right arrow)
11	Back	Used as a button (←) for returning to the start screen.

 Individual menu items are active or inactive depending on the type of control module.

6.12.3 Main menu view 3

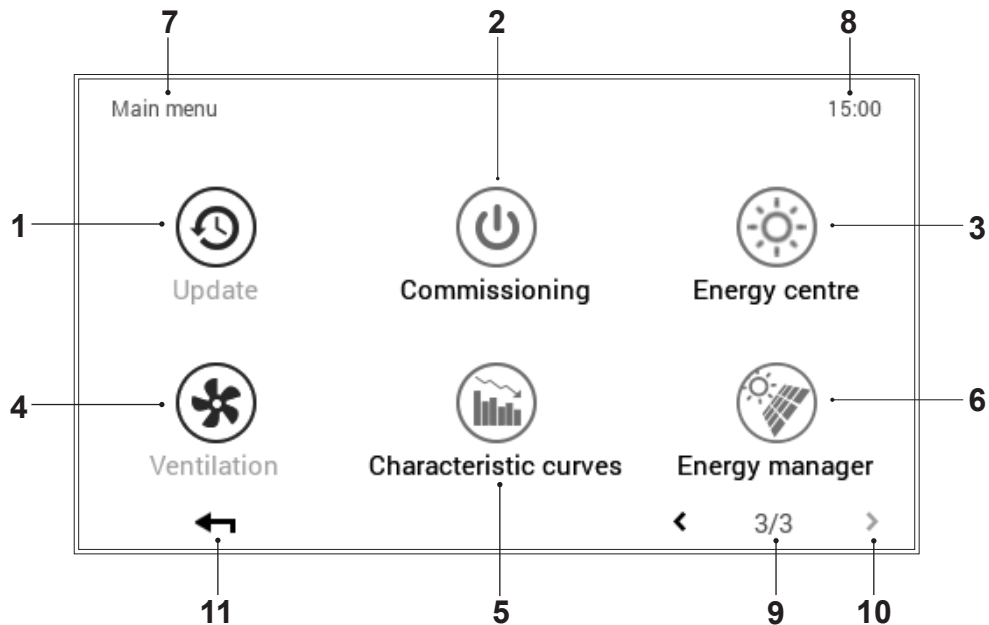

No.	Designation	Function
1	Update	Menu item only for heating specialist
2	Commissioning	Menu item only for heating specialist
3	Power station	Influence of weather forecast on heating. Selection of the heating or hot water circuit to be edited only functions if.
4	Ventilation	Only active in connection with a residential ventilation system. (comfort plus)
5	Heating and cooling characteristic (optional: for heat pumps only)	The characteristic curves are normally set by the specialist during commissioning of the heating system. They describe the ratio between the installation flow temperature and the current outdoor temperature. When using a room control module, the characteristic curves are automatically optimised by the TopTronic® E.
6	Energy Manager	The Energy Manager visualises the power generation and is only active in connection with a photovoltaic system.
7	Position in the menu	Name of the currently selected menu item
8	Time of day	Displays the current time.
9	Page in the main menu	Display of the active main menu page (1)
10	Scroll	Arrow (↩) for navigating from main menu page 3 to main menu page 2
11	Back	Used as a button (←) for returning to the start screen.



Individual menu items are active or inactive depending on the type of control module.

6.12.4 Power station

(Main menu / Energy control)

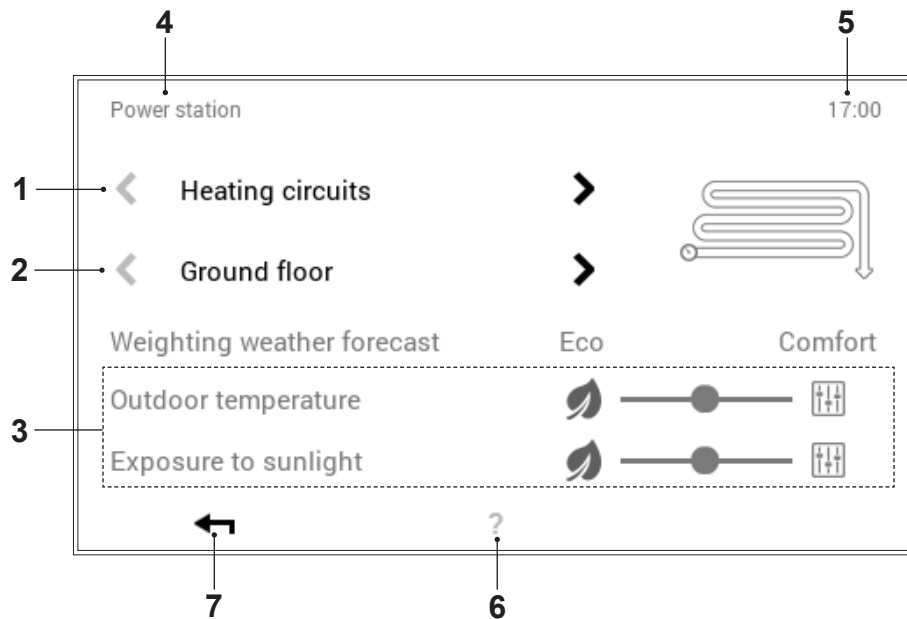

No.	Designation	Function
1	Heating circuits	Selection of the heating circuit to be edited.
2	Circuit selection	There can be several circuits in the selected heating circuit. If the system contains more than one circuit, this is indicated by the white, active horizontal arrows (◀ ▶). If there is only one heating or hot water circuit, the arrows are greyed out.
3	Eco-Comfort slider Outdoor temperature Eco-Comfort slider Exposure to sunlight	<p>If the slider is moved to “Eco”, the heating control (e.g. for underfloor heating) is influenced by the outdoor temperature forecast in the weather forecast to the greatest possible extent.</p> <p>If the slider is moved to “Eco”, the heating control (e.g. for large, south-facing windows) is influenced by the exposure to sunlight information in the weather forecast to the greatest possible extent.</p> <p>If the slider is moved to “Comfort”, the weather forecast is not considered.</p> <div style="border: 1px solid gray; padding: 5px; margin-top: 10px;">  If the forecast is not received, a deviating “heat output” can be expected! </div>
4	Position in the menu	Name of the currently selected menu item
5	Time of day	Displays the current time.
6	Help	No function is available at present
7	Back	Used as a button (←) for returning to the main menu.

6.12.5 Power station
(Main menu / Energy control)

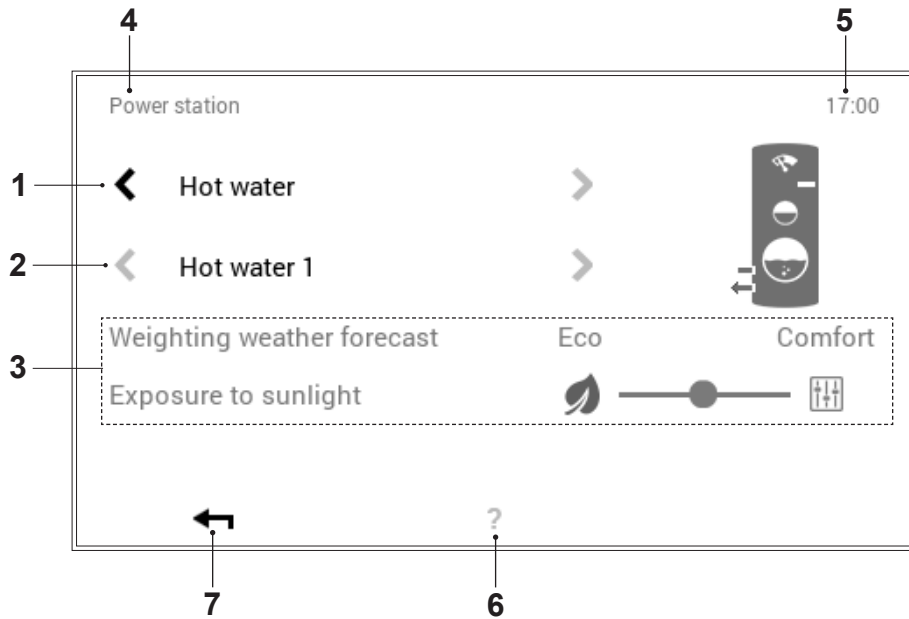

No.	Designation	Function
1	Hot water circuits	Selection of the hot water circuit to be edited
2	Circuit selection	There can be several circuits in the selected hot water circuit. If the system contains more than one circuit, this is indicated by the white, active horizontal arrows (◀ ▶). If there is only one heating or hot water circuit, the arrows are greyed out.
3	Eco-Comfort slider	<p>If the slider is moved to “Eco”, the heat generator is influenced by the weather forecast to the greatest possible extent, i.e. it reduces the amount of hot water in good weather and increases it in bad weather.</p> <p>If the slider is moved to “Comfort”, the weather forecast is not considered.</p> <div style="display: flex; align-items: center;">  <p>If the forecast is not received, a deviating “heat output” can be expected!</p> </div>
4	Position in the menu	Name of the currently selected menu item
5	Time of day	Displays the current time.
6	Help	No function is available at present
7	Back	Used as a button (←) for returning to the main menu.

6.12.6 Programs
(Main menu / Programs)

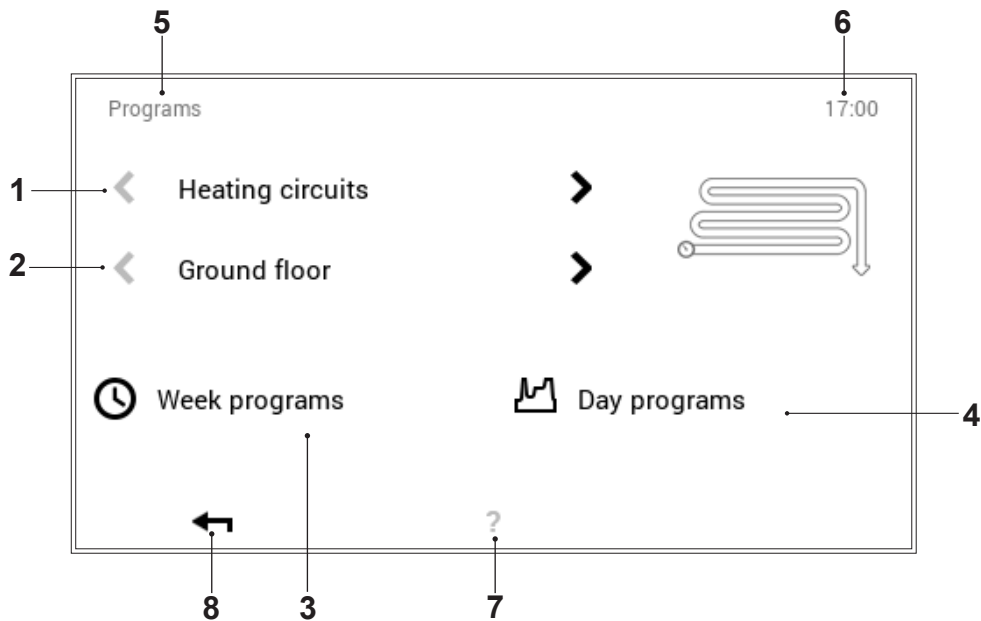

No.	Designation	Function
1	Heating or hot water circuits	Selection of the heating or hot water circuit to be edited. The room temperature is set in the “Heating circuit” menu, the water temperature is set in the hot water circuit. The horizontal arrows (◀ ▶) are used for selecting between the heating or hot water circuit.
2	Circuit selection	There can be several circuits in the selected heating or hot water circuit. If the system contains more than one circuit, this is indicated by the white, active horizontal arrows (◀ ▶). If there is only one heating or hot water circuit, the arrows are greyed out.
3	Week programs	Editing the week programs in the selected heating or hot water circuit. In the week program, a day program can be assigned to the different days of the week, and thus an individual week sequence can be defined (6.9 page 32).
4	Day programs	Day programs can be defined by max. six switching cycles per day. Editing the day programs in the selected heating or hot water circuit. The desired room temperature is set in the heating circuit, the desired hot water temperature is set in the hot water circuit (6.10 page 41).
5	Position in the menu	Name of the currently selected menu item
6	Time of day	Displays the current time.
7	Help	No function is available at present
8	Back	Used as a button (←) for returning to the main menu.

6.12.7 Heating circuit

(Main menu / Heating circ.)

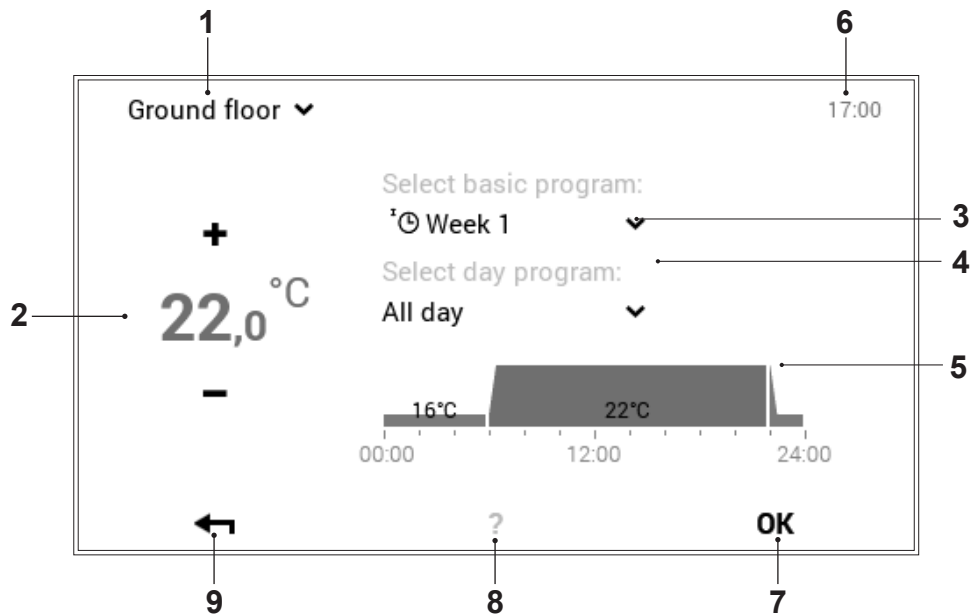

No.	Designation	Function
1	Active heating circuit	Display of the heating circuit to be edited. Changed settings are exclusively accepted in the selected heating circuit. Use the down arrow (▼) to change the heating circuit.
2	Desired temperature	Displays the temperature programmed in the switching cycle. The temperature can be changed in the active switching cycle using plus (+) and minus (-).
3	Basic program	Selection of the basic program. Use the down arrow (▼) to select a new program for editing.
4	Day program	Use the down arrow (▼) to change the day program.
5	Switching cycles	Graphical display of the currently selected day program with all time cycles and corresponding temperature specifications. The time period marked in yellow shows the currently active cycle in which the desired temperature can be changed with plus (+) and minus (-).
6	Time of day	Displays the current time.
7	OK	Save (OK) the changes in the selected heating circuit and return to the previous screen
8	Help	No function is available at present
9	Back	Used as a button (←) for returning to the main menu.



Temporary settings “Only for today” are not possible in the “Heating circ.” menu item.

6.12.8 Info

(Main menu / Info)

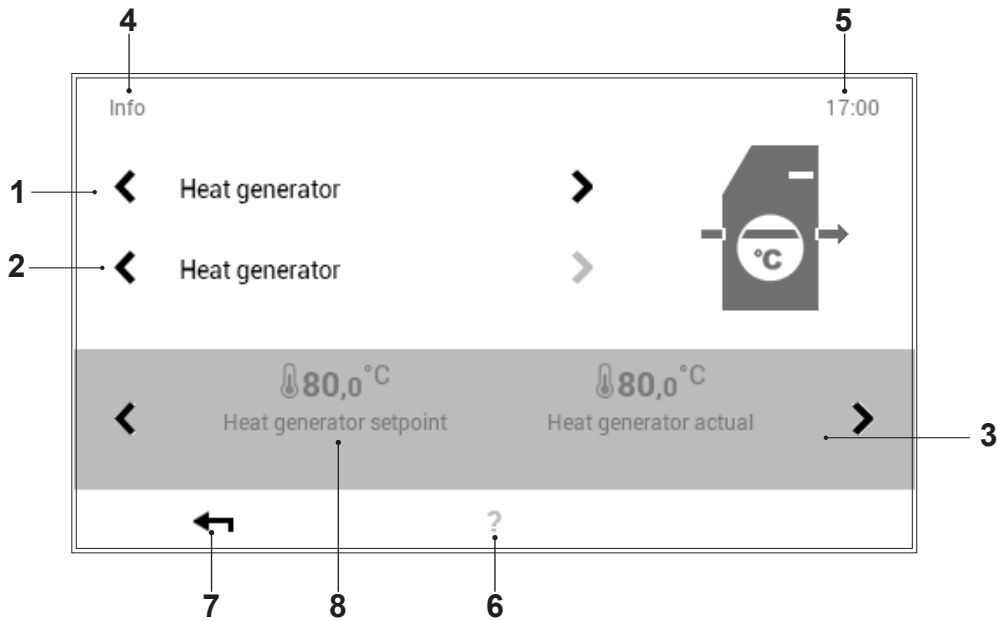

No.	Designation	Function
1	Heat generator / heating circuits / hot water	Selection of the system part. It is possible to switch between the heat generator, the heating circuit and the hot water area using the horizontal arrows (< >).
2	Detailed selection	Selection of the desired heat generator, heating circuit or hot water circuit. If the system contains several circuits, this is indicated by the white, active horizontal arrows (< >).
3	Information	Information about the selected system area. Additional output information can be displayed on the screen using the horizontal arrows (< >).
4	Position in the menu	Name of the currently selected menu item
5	Time of day	Displays the current time.
6	Help	No function is available at present
7	Back	Used as a button (←) for returning to the main menu.
8	Heat generator setpoint	With heat pumps: Under certain circumstances, at very low outside temperatures, it will not be possible to reach the required domestic hot water temperature or room temperature (the reference value is changed by the machine so that there will not be a fault cut-out).

6.12.9 Analysis

(Main menu / Analysis)

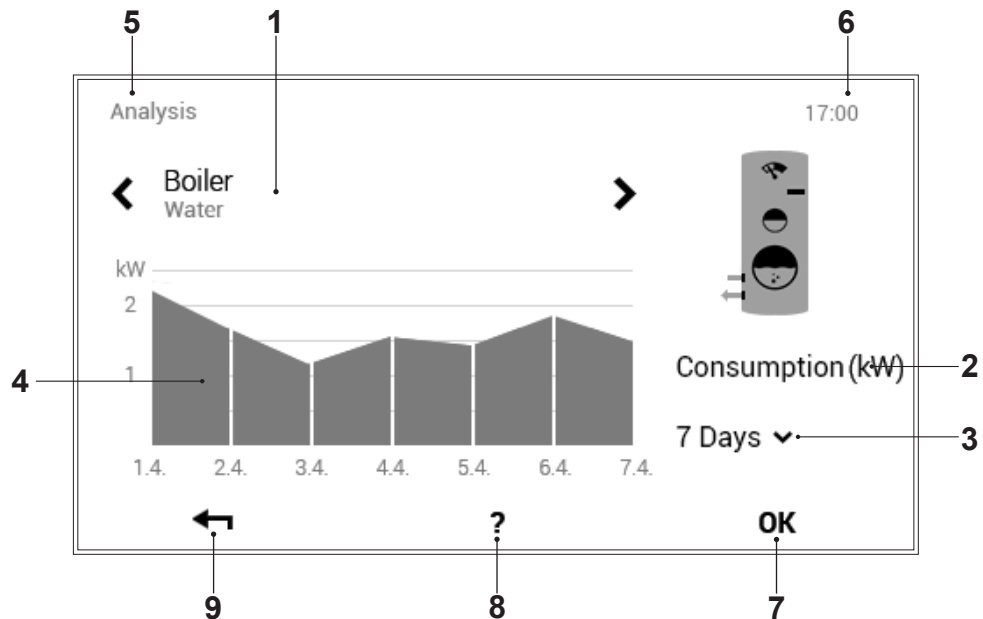

No.	Designation	Function
1	Heat generator / heating circuits / hot water	Selection of the area to be analysed. It is possible to select between the heat generator, the heating circuit and the hot water area using the horizontal arrows (< >).
2	Measuring parameter	Display of the recorded measuring parameter
3	Selection duration	Use the down arrow (▼) to select the required duration.
4	Analysis / graphic	Display of the measuring parameter of the selected heat generator, heating circuit or hot water in the desired duration
5	Position in the menu	Name of the currently selected menu item
6	Time of day	Displays the current time.
7	OK	Save (OK) the changes in the selected heating circuit and return to the previous screen
8	Help	No function is available at present
9	Back	Used as a button (←) for returning to the main menu.

6.12.10 Emission - only for heating specialist

(Main menu / Emission (not in with Heat pumps))

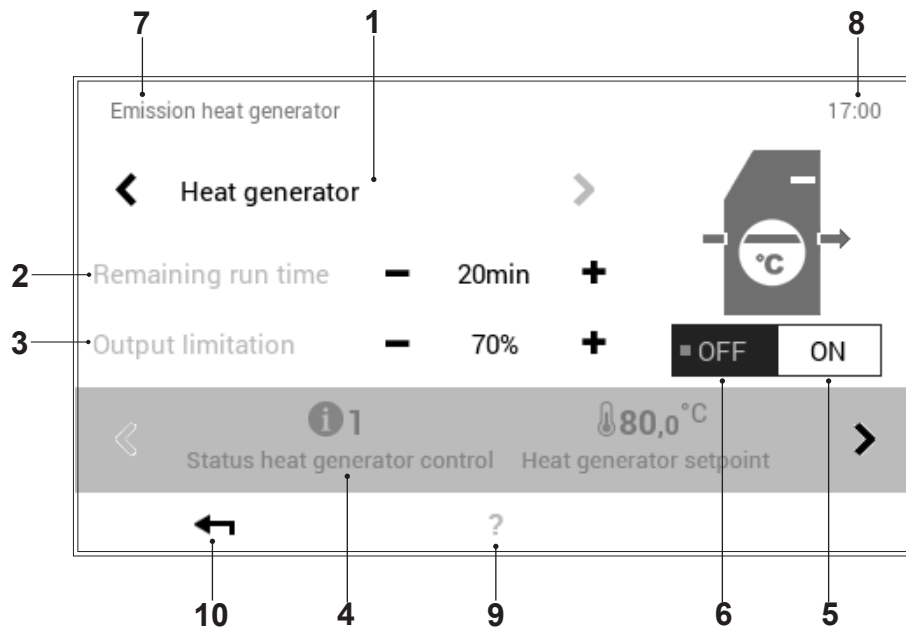

No.	Designation	Function
1	Selection heat generator	Display of the heat generators present in the heating system. The horizontal arrows (< >) are used for selecting the required heat generator.
2	Time	Duration of emission measurement. Setting the required time with plus (+) and minus (-), i.e. to be defined by the heating specialist before the start of the measurement. The heat generator is switched off after the time has elapsed.
3	Power limitation	Entry of the required power limitation. Regulation of the required power limitation by plus (+) and minus (-).
4	System information	Information about the system in the selected heat generator. Additional information can be displayed with the horizontal arrows (< >).
5	ON	Switching on the heat generator
6	OFF	Switching off the heat generator
7	Position in the menu	Name of the currently selected menu item
8	Time of day	Displays the current time.
9	Help	No function is available at present
10	Back	Used as a button (←) for returning to the main menu.



The emission measurement is automatically deactivated when the "Emission" menu item is exited!

6.12.11 Manual operation

(Main menu / Manual operating mode)

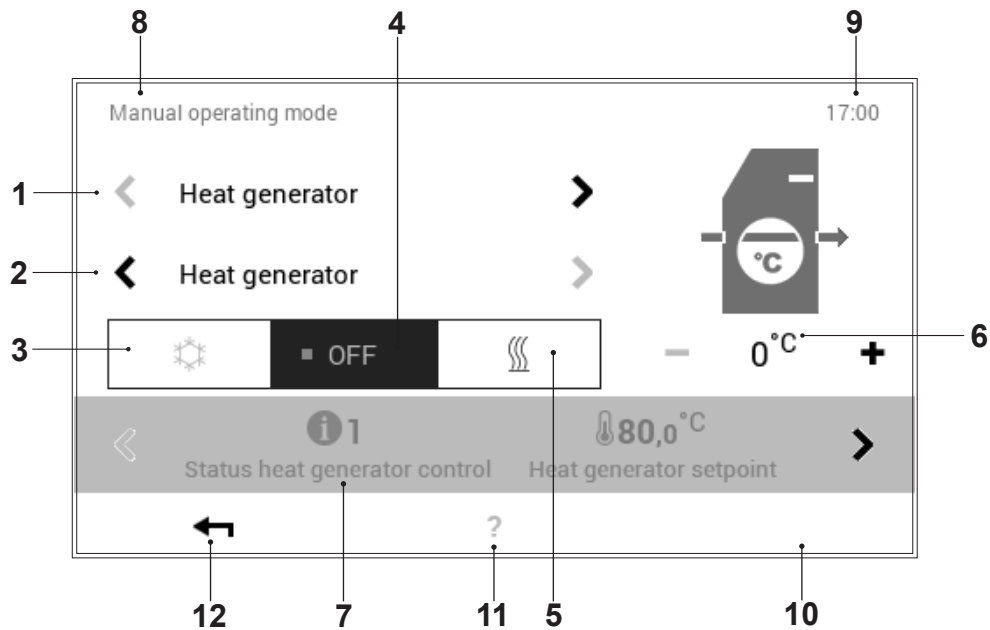

No.	Designation	Function
1	Heat generator / heating circuits	The control permits individual manual operation, i.e. manual operation can be activated on any heat generator and heating circuit that is present.
2	Detailed selection	Selection of the desired heat generator or heating circuit. The system can include several heat generators and heating circuits. If there is more than one heat generator/circuit, the horizontal arrows (◀ ▶) are shown in white. If there is only one heating or hot water circuit available for selection, the arrows are greyed out and cannot be selected.
3	Cooling	Activation of cooling operation (if possible in the system)
4	OFF	Switch off active manual operation. The system switches over to automatic operation.
5	Heating	Activate "Heating" manual operation
6	Temperature	Display of the desired temperature. The temperature can be changed using plus (+) and minus (-).
7	Information	Information about the selected manual operation. Additional information can be displayed on the screen with the horizontal arrows (◀ ▶).
8	Position in the menu	Name of the currently selected menu item
9	Time of day	Displays the current time.
10	OK	Save (OK) the changes in the selected heating circuit and return to the previous screen
11	Help	No function is available at present
12	Back	Used as a button (←) for returning to the main menu.

6.12.12 Presentation 1

(Main menu / Presentation)

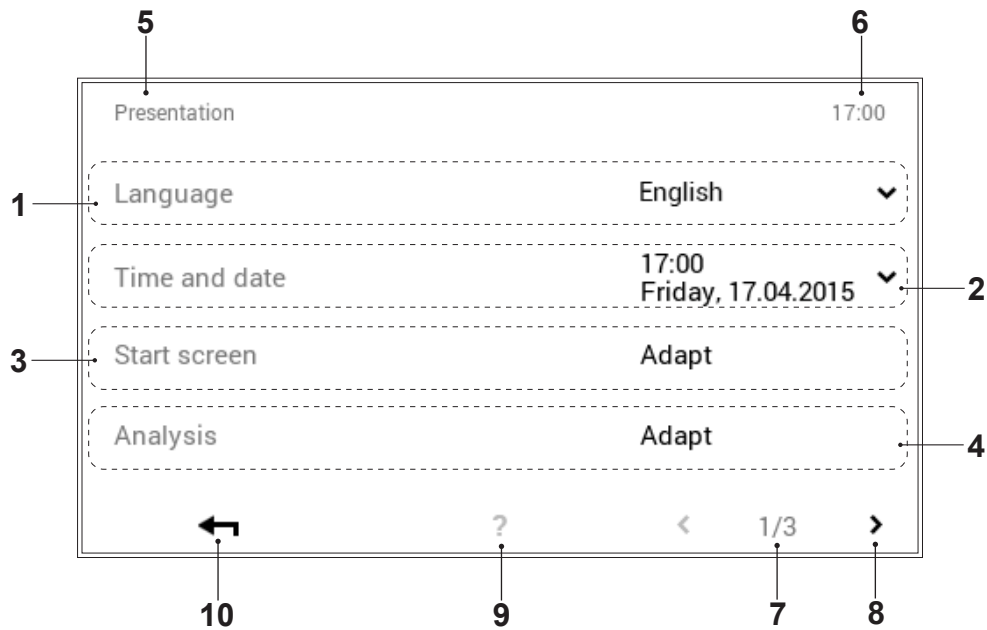

No.	Designation	Function
1	Language	Selection of the desired language. The active language can be selected with the down arrow (▼).
2	Time & date	Changing the current date and time
3	Start screen	Selection of the display elements you want on the start screen. Select the "Adapt" button to make adaptations to the start screen.
	Changing the start screen	To change the desired «Start screen», see 6.6.2 page 20.
4	Analysis	Setting of the values to be recorded (analysis).
5	Position in the menu	Name of the currently selected menu item
6	Time of day	Displays the current time.
7	Page in the menu	Display of the active menu page (1). Menu page 3 only for heating specialist.
8	Scroll	Arrow (▶) for navigating from menu page 1 to page 2
9	Help	No function is available at present
10	Back	Used as a button (←) for returning to the main menu.

6.12.13 Presentation 2

(Main menu / Presentation)

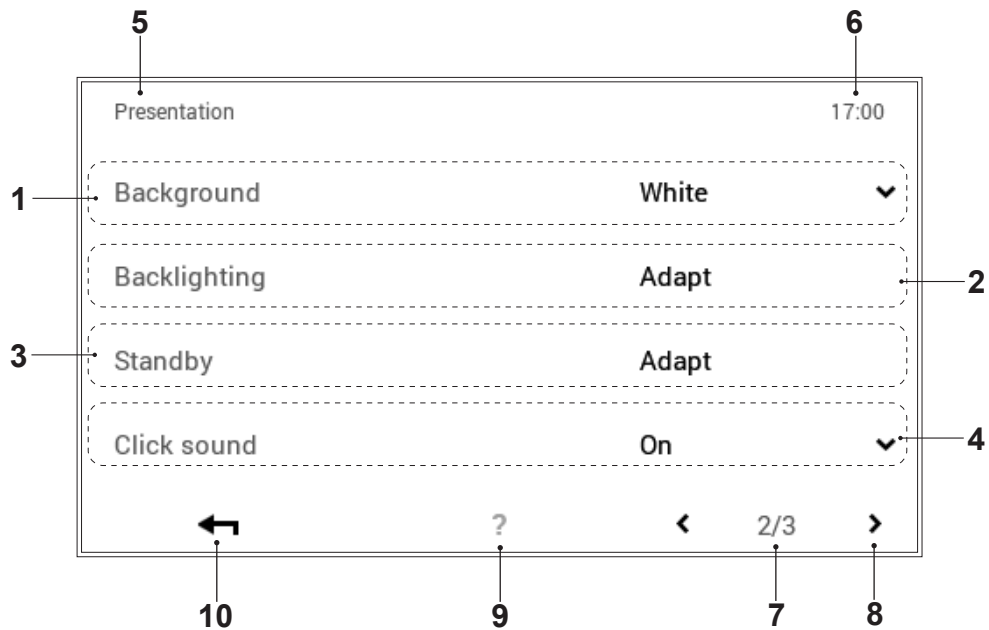

No.	Designation	Function
1	Background	Adaptation of the colour scheme of the control. The arrow key (▼) can be used for selecting between a black and a white background.
2	Backlighting	Adaptation of the current display mode, time until the screen is darkened as well as percentage specification for maximum and minimum screen brightness.
3	Standby	<p><u>Standby behaviour</u> Screen with active standby modus. Depending on the selection, when the screen enters standby mode, it switches to the start screen, to the “Visualisation” main menu item or to sleep mode (black screen). Selecting “No standby” means that standby mode is deactivated.</p> <p><u>Duration until standby</u> Entry of the required number of minutes until the control enters standby mode. The number of minutes can be changed with plus (+) and minus (-). To deactivate standby mode, it is necessary for “No standby” to be selected in the “Standby behaviour” menu item (no. 4).</p> <p><u>Sleep mode at night</u> When it is dark, the touchscreen automatically switches to sleep mode, i.e. the screen switches itself off and is reactivated when daylight returns.</p> <p><u>Operation lock of the screen:</u> For activation/deactivation of the operation lock, a sequence of numbers (freely selectable - keep in a safe place) must be entered. After entry, touch the “Confirm operation lock” message to activate it.</p>
4	Click sound	Can be switched on/off
5	Position in the menu	Name of the currently selected menu item.
6	Time of day	Displays the current time.
7	Page in the menu	Display of the active menu page (2).
8	Scroll	Arrow (◀) for navigating from menu page 2 to page 1.
9	Help	No function is available at present.
10	Back	Used as a button (←) for returning to the main menu.

6.12.14 Presentation 3

(Main menu / Presentation)

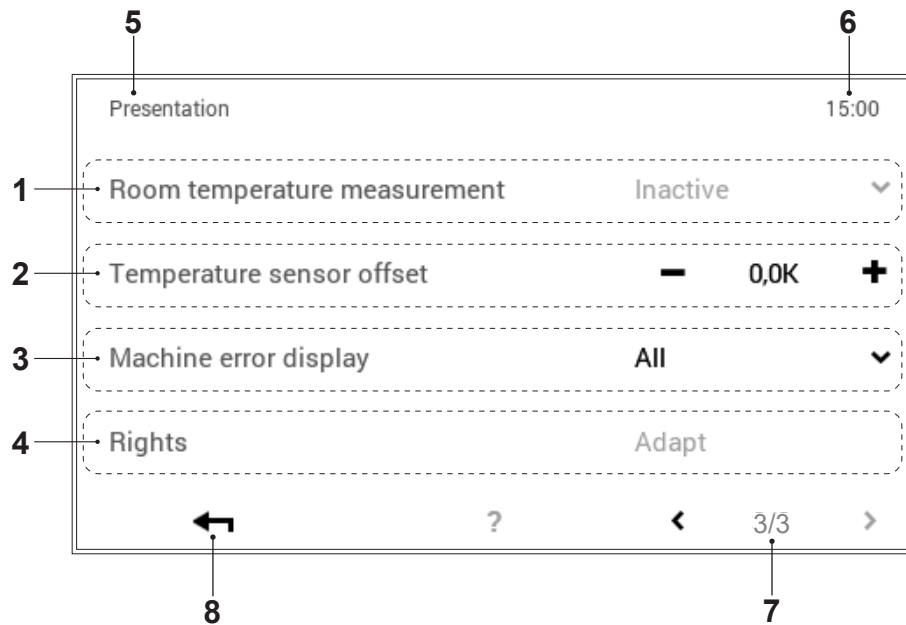

No.	Designation	Function
1	Room temperature measurement	Can only be adjusted by the specialist
2	Temperature sensor offset	For the heating technician only
3	Machine error display	For the heating technician only
4	Permissions	Can only be adjusted by the specialist
5	Position in the menu	Name of the currently selected menu item.
6	Time of day	Displays the current time.
7	Page in the menu	Display of the active menu page (3).
8	Back	Used as a button (←) for returning to the main menu.

6.13 Further settings

6.13.1 Set/change WiFi password



If there is a change of provider (Internet service provider), the WiFi password must be re-entered so that the system will connect to the Internet again. The WiFi logon can be carried out on any operating module.

You will find a video tutorial under the following online link, which explains how to enter a new password.

- Alternatively, you can also scan the QR code to access the video!

<https://youtu.be/sATBGdIpnSw>

6.13.2 Setting the language

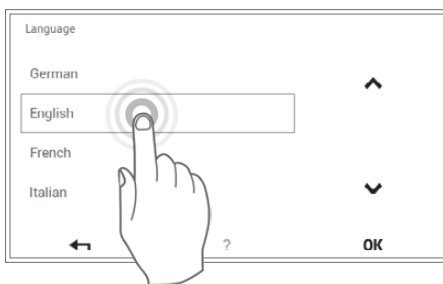

The language of the control can be changed at **Start screen > Main menu (⚙) > Presentation > Language** (6.12.12 page 70, no. 1).

6.13.3 Adapt start screen individually

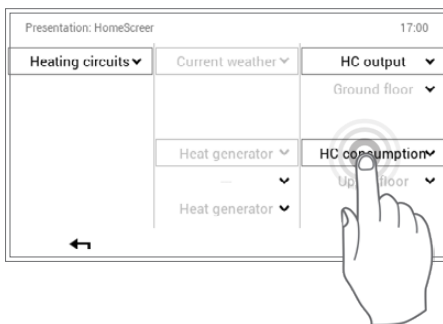

The elements of the start screen can be individually adapted at **Start screen > Main menu (⚙) > Presentation > Start screen** (6.12.12 page 70, no. 5).

6.13.4 Rename heating circuit

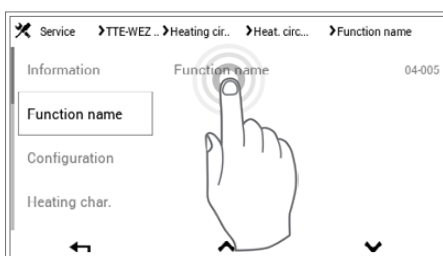

You can give a name to your heating circuit at **Start screen > Main menu > Service > TTE-WEZ > Heating circ. > Select heating circuit > Function name (↕) > Select function name > Select heating circuit > Keyboard inputs**. Bear in mind that your system can include one or more heating circuits.

7. Alarm messages

7.1 Display alarm message

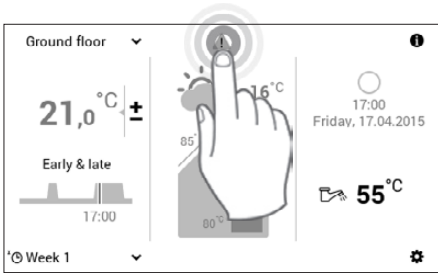

1 Touch the displayed **alarm message icon** to select it.

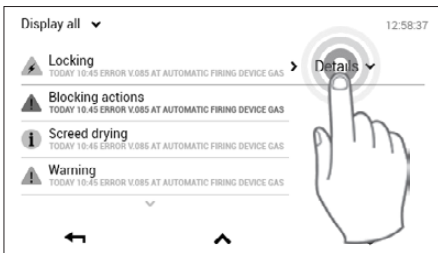

2 Touch **Details** (▼) to select it.



Use the **Display All** (▼) button at the top left of the screen to select all prior alarm messages by category (information, warning, etc.).

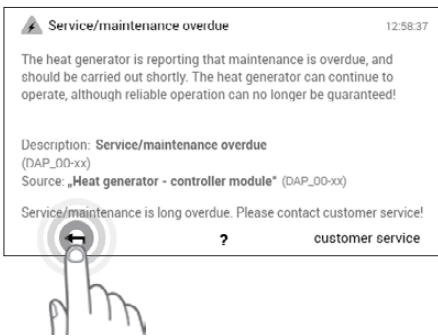

3 A detailed alarm message appears. The message contains detailed information about the malfunction. Use **Back** (←) to close the alarm message view.

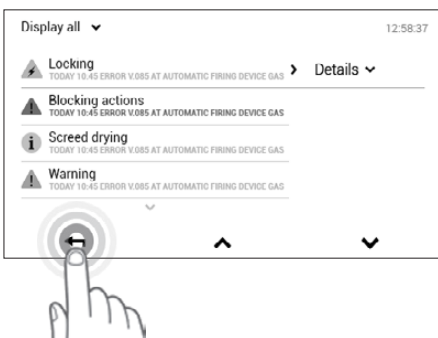

4 Select **Back** (←) again to close the **alarm message overview**.

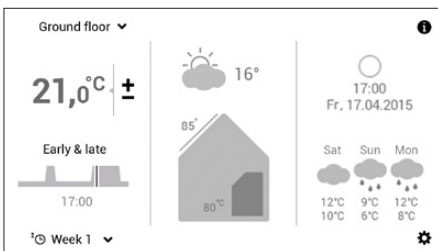

5 Once the malfunction has been rectified, the alarm message icon is no longer displayed in the start screen.

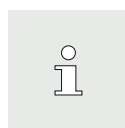

If alarm messages cannot be rectified using the information displayed on the control module, contact Hoval customer service.

7.2 Instructions in the event of faults

1. If the heat generator does not start check if the blocking switch is set to "I".
2. For resetting the fault, see below (point 7.3).
3. Pressing the alarm message icon allows the alarm messages to be requested (see also points Pkt. 7.1 and 6.6.1).

7.3 Resetting the faults

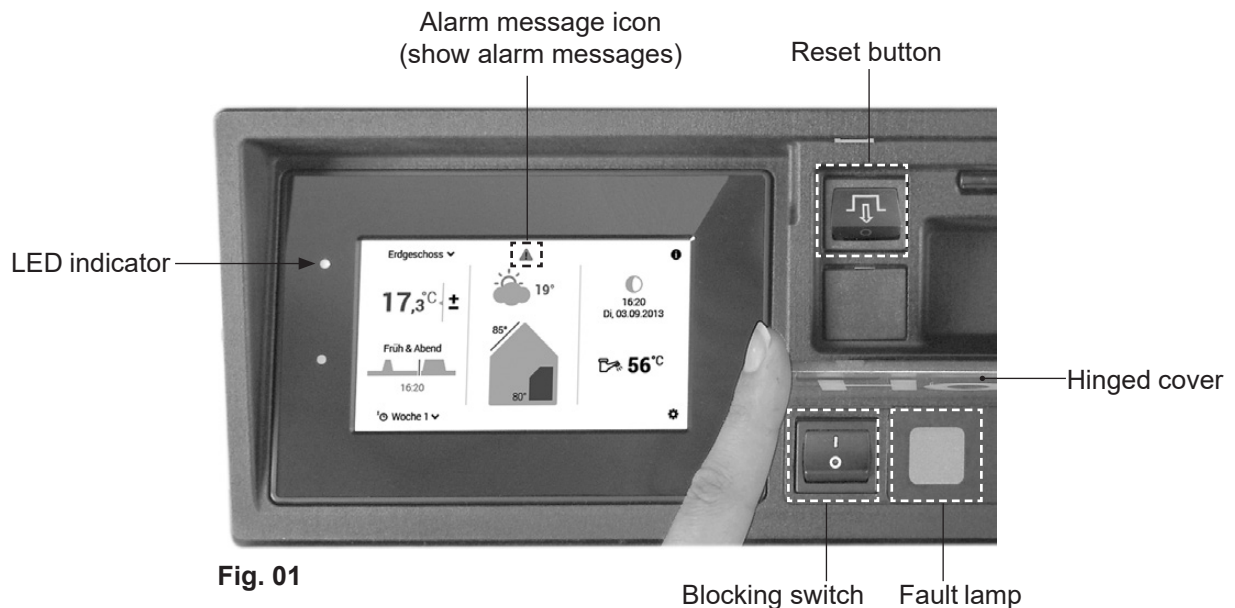

Faults can be recognised by the alarm message icon and/or by a red-orange flashing LED indicator to the left of the operating field (see also point 6.6.1 page 18, Pos. 6).

If, in addition, the fault lamp next to the blocking switch lights up, the heating operation was stopped. The fault can be acknowledged by pressing the reset button.



The reset button is allowed to be pressed once at most. If the failure indication lamp continues to be lit, please contact Hoval Customer Service.

1. Open the Hinged cover (Fig. 01) on the right of the control panel.
2. Press the reset button for 3 seconds. If the fault lamp goes out, the heat generator carries out a start attempt. If the fault lamp does not go out or lights up again after the start attempt, please contact Hoval Customer Service.

7.4 Control related alarm messages



You can deal with the alarm messages listed below yourself, with the help of the description. If an alarm message appears on your TopTronic® E control module that is not listed below, please contact Hoval Customer Service.

Fault / cause	Remedy
<p>▲ Locking STB - flue gas (E:40)</p>	<p>Exceeding of the maximum permissible flue gas temperature Contact Hoval Customer Service.</p> <div style="border: 1px solid black; padding: 5px; margin-top: 10px;"> <p>WARNING  Danger of poisoning by repeated unlocking! If this error message appears, immediately contact the heating specialist.</p> </div>

7.5 Plant-related alarm messages

Malfunction	Inspection/cause	Remedy
Oil boiler does not start	- Is power supply present?	- Check fuses. Switch on the main/emergency switch or plug in the power plug.
	- Is the red fault indicator lit?	- Press the reset button on the control panel - Call Hoval customer service
	- Oil level check	- Top up oil
	- Is the burner connector plugged in?	- Plug in the connector
	- Has the safety temperature limiter tripped?	- Call Hoval customer service
Radiators or underfloor heating do not become warm	- Are the slide valves in the heating flow and return open?	- Open slide valve
	- Is the blocking switch in position "0"?	- Change over the blocking switch
	- Checking the water pressure	- Top up and vent heating system
	- Are the radiator valves open?	- Open the radiator valves
	- The heating circulating pump is not running	- Unscrew locking screw - Turn end of shaft vigorously with a screwdriver until there is no longer resistance
- Mixing valve does not open automatically	- Set the mixing valve to manual operation; open by hand - Call Hoval customer service	
No hot water	- The charging pump is not running	- Unscrew locking screw - Turn end of shaft vigorously with a screwdriver until there is no longer resistance
	- Is there air in the charging pipe?	- Possibly vent manually - Operate automatic air vent by hand
	- Has the safety temperature limiter tripped?	- Unscrew the nut and unlock by pressing the Reset button



Please use the above checklist when carrying out the checks in the case of malfunctions. If you are not able to resolve the fault, please contact the heating specialist or Hoval Customer Service.

8. Maintenance and inspection (heating system)



The work described below is normally performed by the heating specialist in the course of annual maintenance. Nevertheless, carry out the following checks during the year and perform the work described as necessary.

8.1 Checking the water pressure

! **NOTICE**

- If the system water pressure is too low (check pressure gauge (Fig. 02)), top it up with water (chapter 8.2) or inform your heating specialist.
- Danger of corrosion due to frequent topping up (more than 1x/year) – contact the heating specialist.
- Complete filling and draining must be performed by the heating engineer.



Fig. 02

8.2 Top up with water

The replacement water must be of the required quality. The quality requirements are stated in the installation instructions in the “Water quality” chapter (paragraph: Filling and replacement water). If the heating system is filled with frost protection agent or treated water, the heating specialist’s instructions must be followed.

Procedure

1. Set the blocking switch to “0” and disconnect the heat generator from the mains (main switch, fuse, etc.)
2. The mixing valve (manual adjustment) and the shut-off valves in the heating flow and return must be open
3. The connection between the filling valve and the water tap is made using a hose: fill the hose with water before establishing the connection to prevent any air from entering the heating system
4. Slowly fill with water while checking the water level on the pressure gauge
5. Open the bleed valves after topping up until all the air has been vented from the heating system
6. Unscrew the hose again after filling to break the connection reliably
7. Check the water pressure again
8. Switch the system on again

8.3 Cleaning



Insufficient cleaning not only leads to increased fuel consumption, it also shortens the service life of the boiler.

With oil firing systems, arrange for the boiler to be cleaned by the chimney sweep according to national regulations. The boiler must be cleaned and serviced 1x per year. For more information about cleaning, refer to the technical data/installation instructions for UltraOil®.

8.4 Decommissioning

The following measures must be taken if the compact heat station or the boiler is taken out of operation for several weeks:

Where there is a risk of frost, have the system drained as prescribed by the heating specialist or add frost protection agent.

Your plant is equipped with electronic heating control; if there is a risk of frost, a minimum room temperature of 5 °C is ensured when the plant is operational.

Recommendation:



Oil tank check

The oil tank must be checked and cleaned according to legal regulations. Contact a specialist company to have the tank inspected.

Recommendation: check if your liability assurance will cover any damage caused by the possible leakage of oil.

Boiler analysis

After 8 to 10 years of operation, a thorough check by Hoval customer service is recommended.

9. Saving energy

9.1 Specific steps for saving energy

ENERGY



With only a few simple measures, you can



Save energy on a sustainable basis



Cut energy costs



Protect the environment.

It's easy! Just bear in mind the following tips:

- **Set the room temperature and the heating times independently!**
Adapt the heating times and room temperatures according to when you will be present and absent (6.10.3 page 43 and 6.8.2 page 30). A temperature reduction of only 1 °C can save 6% of your energy costs.
- **Correct ventilation**
Ventilate every three to four hours for a few minutes with the window full open, preferably with a through draft. Avoid leaving the windows tilted open when it is cold outside! Correct heating and ventilation also help to prevent mildew forming. Ventilation is not necessary if you are using a domestic ventilation unit.
- **Close roller blinds and shutters at night**
Keep the roller blinds and shutters on doors and windows closed at night to reduce energy losses. If necessary, seal gaps and cracks at windows and doors.
- **Do not obstruct radiators**
Avoid placing furniture in front of radiators. Also avoid closing curtains during the day. At night, on the other hand, they can have an insulating effect. Furthermore, avoid drying damp laundry directly on the radiators. The heat generated by the radiators cannot get into the room in the first place and the hot water is merely circulated.
- **Reduce the room temperature at night**
Save energy while you sleep by reducing the room temperature at night. The room should not cool down excessively, though. This increases the energy required to reheat it, and pipes could freeze.
- **Set the domestic hot water temperature**
Set the domestic hot water temperature as low as possible. Aim for temperatures between 45 °C and 60 °C. Remember to activate the legionella function once a week in the week programme (6.11.6 page 55).
- **Take a shower rather than a bath**
A bath consumes about three times as much energy and water as a shower.
- **Regular maintenance**
Have your heating system regularly cleaned and checked by a specialist. We therefore recommend that you conclude a service contract with your Hoval customer service department. Bleed the radiators if you hear noises coming from the pipework or if the radiators do not achieve an even temperature.

10. Waste disposal

10.1 Disposal instructions



After the end of the service life, the individual system components must be disposed of correctly. Please contact the heating specialist regarding recycling your heating system.



Dismantling must be performed by a heating specialist.

United Kingdom

Hoval Ltd.

Northgate
Newark
Nottinghamshire NG24 1JN
Phone +44 1636 67 27 11
Fax +44 1636 67 35 32
www.hoval.co.uk

Principality of Liechtenstein

Hoval Aktiengesellschaft

Austrasse 70
LI-9490 Vaduz
Phone +423 399 24 00
Fax +423 399 24 11
www.hoval.com

Switzerland

Hoval AG

General Wille-Strasse 201
CH-8706 Feldmeilen
Phone +41 44 925 61 11
Fax +41 44 923 11 39
www.hoval.ch

Germany

Hoval GmbH

Humboldtstrasse 30
DE-85609 Aschheim-Dornach
Phone +49 89 92 20 97-0
Fax +49 89 92 20 97-77
www.hoval.de

Austria

Hoval Gesellschaft mbH

Hovalstrasse 11
AT-4614 Marchtrenk
Phone +43 50 365 - 0
Fax +43 50 365 - 5005
www.hoval.at

Italy

Hoval s.r.l.

Via XXV Aprile 1945, 13/15
IT-24050 Zanica (BG)
Phone +39 035 666 1111
Fax +39 035 526 959
www.hoval.it

France

Hoval SAS

Parc d'Activité de la Porte Sud
Bâtiment C - Rue du Pont au Péage
FR-67118 Geispolsheim
Phone +33 388 60 39 52
Fax +33 388 60 53 24
www.hoval.fr